

# Software

CX-One		
Introduction		628
Configuration	CX-Integrator	630
PLC Programming	CX-Programmer	631
	CX-Simulator	634
	CX-Protocol	636
Motion	CX-Motion	638
	CX-Position	639
	CX-Motion NCF	640
	CX-Motion MCH	641
	CX-Drive	642
Regulation	CX-Process Tool	643
	CX-Thermo	644
HMI	CX-Designer	645
Network & Fieldbus	CX-PROFIBUS	647
PC Specifications		648
Ordering information		652
PC based visualisation		
	CX-OPC	653
	CX-Lite	654
	CX-Supervisor	655
PC Specifications and Ordering Information		657

# Smart Platform

Smart Platform, Omron's new integrated automation architecture, demonstrates Omron to be one of the most innovative players in the market. Designed to simplify machine automation, the goal of Smart Platform is to allow increasingly complex machines to be developed, commissioned and maintained easily, allowing you time to 'just create'.

Driven by the need to make connectivity as simple and flexible as possible, Omron's Smart Platform creates a harmonious combination of sensing, control, motion and regulation devices. It enables users to mix and match their preferred solutions without the need to worry about hierarchy or other communication issues.

The Smart Platform concept is built around three major advantages for the user:

- One software
- One connection
- One minute

## One software.

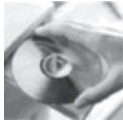

This single programming and configuration environment is an integrated software management tool called CX-One that enables the user to build, configure and program networks, PLCs, HMIs, motion control systems, drives, temperature controllers and sensors. The result of a single software is to reduce complexity of the configuration and allow automation systems to be programmed or configured with minimal training.

## One connection.



From a single connection point either locally, through networks or from a modem connection the Omron 'Smart Platform' devices on your machine can be programmed or parameterised. This allows remote access or servicing of your complete machine to become a reality. The same transparent communications architecture also allows Omron devices to easily communicate together passing and sharing information and enabling more effective modular machine design.

## One minute.



SMART Active Parts greatly increase the functionality & information that is available to operators through Omron's HMI. Written and tested for you by Omron's control experts these "drag and drop" visualization objects are called Smart and Active because they automate the communication from the NS HMI-series to all connected Omron products. (e.g. 'read actual speed' of an inverter, view a scene from a vision sensor, represent a temperature controllers etc.).

Function Blocks offer similar 'drag & drop' programming and functionality ('read actual speed' of an inverter, change a scene from a vision sensor, configure a temperature controllers) but they are used within the PLC. They can be programmed in Ladder or Structured Text, and can contain up to 16 layers of 'nested' function blocks (Function Block inside Function Block).

For further information about Smart Platform go to <http://www.smartplatform.info>

## Just create

Motion control applications are perceived to be difficult and complex to setup, program and test, as need highly skilled people to get simple movements. However if you are to offer any flexibility in your machine then you must implement electronic motion control !

	Traditional approach	With Smart Platform
1 Wire up	<p>10 core cable for each axis</p> <p>2 hours</p>	<p>Simple co-ax connection</p> <p>1 minute</p>
2 Configure	<p>Different software, cables and connections</p> <p>20 minutes</p>	<p>Integrated software</p> <p>1 minute</p>
3 Test	<p>Detailed studying required before operation</p> <p>3 hours</p>	<p>Pre-made objects to test motion</p> <p>1 minute</p>
4 Program	<p>Complex ladder code</p> <p>Xx? hours</p>	<p>Drag n drop standard blocks</p> <p>1 minute</p>

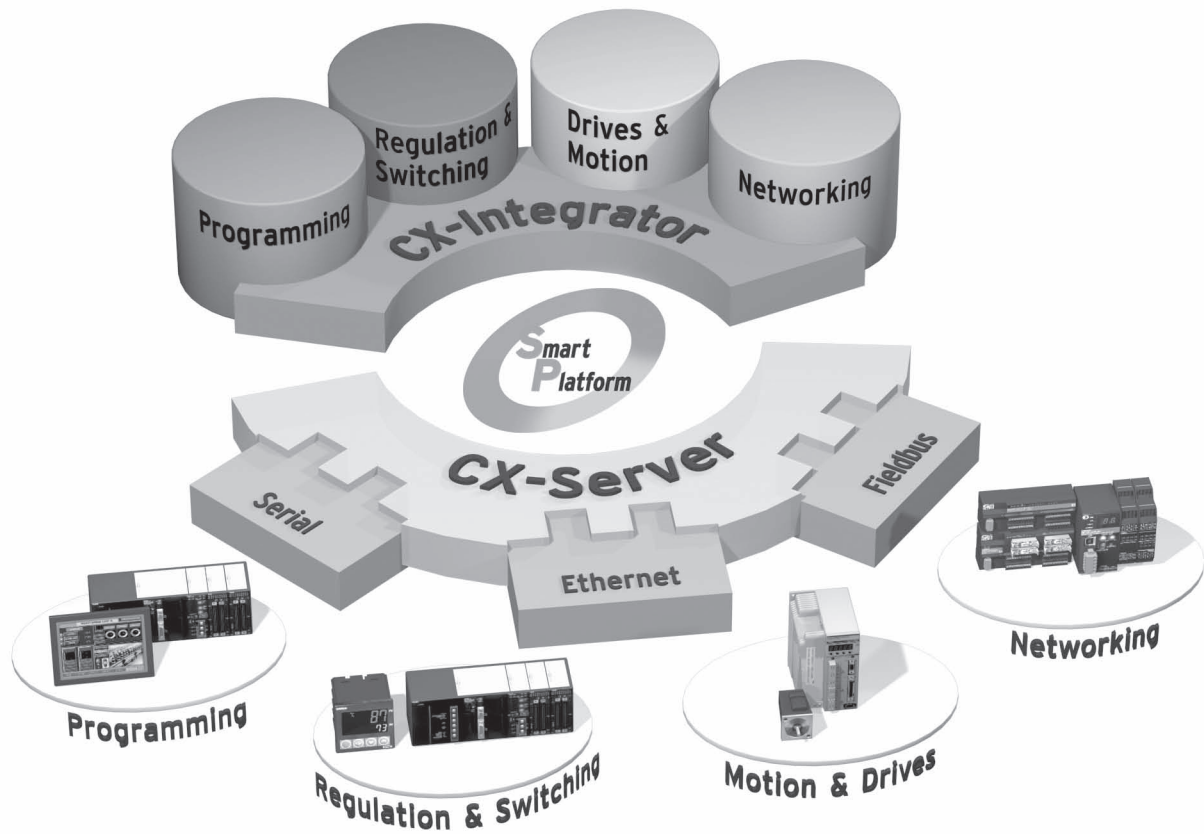

**CX-One** - one software

CX-One covers all your requirements for complete machine automation

**Programming**

- CX-Programmer (PLC programming)
- CX-Simulator (PLC simulation)
- CX-Designer (HMI programming)

**Motion & Drives**

- CX-Motion – for motion controllers with analogue output
- CX-Position – for PTP controllers with pulse output
- CX-Motion – NCF for PTP controllers with motion bus MUI

- CX-Motion – MCH advanced motion with motion link MUI
- CX-Drive – for inverters and servo-drives

**Regulation and Switching**

- CX-Process for PLC process units
- CX-Thermotools for stand-alone temperature controllers

**Networks**

- CX-Integrator (DeviceNet + Ethernet + Controller link)
- CX-profibus: all profibus modules

Configuration

# CX-Integrator

The CX-Integrator the main configuration software for CX-One. It enables easy performance of many operations, such as monitoring the connection status of various networks, setting parameters, and diagnosing networks. The CX-Integrator can be placed online manually or automatically with the Omron CS/CJ-series PLC's through which the user can upload, download or monitor network or specific device parameters for each network.

Direction connection using serial communications (for temperature control or sensing applications) is possible without going through a PLC. The serial Compoway/F network configuration can be uploaded or automatic connection is possible. Furthermore, parameters in slaves on the networks can be set, edited, uploaded, and downloaded. Whenever required, network configuration information can be saved in files. The configuration information in previously saved files can be later compared to the actually current configuration.

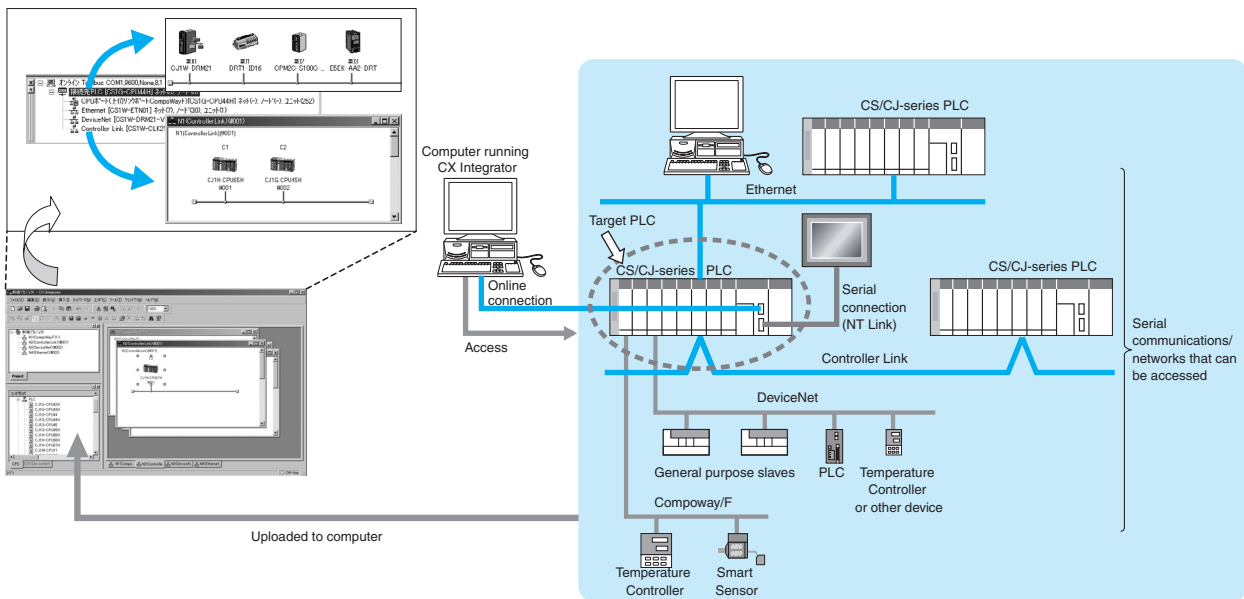

**PLC**  
Omron's range of CS and CJ PLC's can be fully programmed and configured. Also if the PC is connected to a CS or CJ PLC Omron utilize advanced communication functionality to allow unparallel access to all other networks, fieldbus system, serial networks through the PLC allowing 'One Connection' to all networks or Devices on the machine.

**DeviceNet**  
DeviceNet networks and the devices on the network can be created, configured, copy&pasted, and on-line functionality includes upload/download/verify, monitoring and maintenance functions. Files can be saved for easy reuse in other projects.

**Networks**  
Ethernet and Omron Controller-Link peer-peer networks can be created, configured, copy&pasted, and on-line functionality includes upload/download/verify, monitoring and maintenance functions

**HMI**  
NS-Series HMI terminals can be created, and the programmed either directly, or through PLC's or simply across Ethernet networks to ensure that a 'single connection' is all that is needed.

**Sensing and regulation**  
Stand-alone or serially networked temperature control or sensing devices can be programmed or configured from CX-Integrator. Also parameters can be uploaded, downloaded, stored and retrieved.

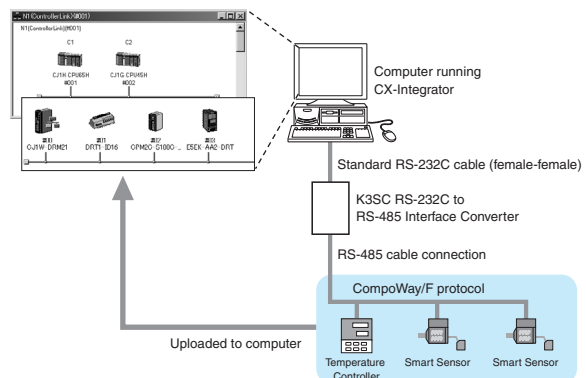

# PLC Programming CX-Programmer

Reduce application development and testing time and increase machine functionality with CX-Programmer.

Programming software for SYSMAC CS, CJ, C, and CVM1/CV series PLC ladder programs

CX-Programmer provides one common PLC software platform for all types of Omron PLC controllers – from micro PLC's up to Duplex processor systems. It allows easy conversion and re-use of PLC code between different PLC types, and the full re-use of control programs created by older generation PLC programming software.

Many powerful documentation features are available to clearly document the intended use and operation of the control code can be stored inside the PLC. An advanced 'project comparison' function is included to allow in-detail comparison between the PLC project and the PC project.

Easy integration with other Omron software products allows sharing of Tag comments to reduce mistakes, reduce development time and increase ease of use.

Maintenance features allow easy searching of contacts and coils with a single click, thereby allowing fast identification of the cause of machine or line stoppages while monitoring, display, and debugging functions reduce engineering time and implementation costs.

Advanced data trace and time chart monitoring reduces maintenance and troubleshooting time. This can then be used to either fine-tune the performance of the machine, or reduce and optimize the cycle time of the machine.

## Powerful, Easy-to-use Functions

### Powerful, Easy-to-use Ladder Editor

The ladder create, search, and jump operations can be executed with a single keystroke for efficient programming and debugging. Also, the various comment functions make ladder programs much easier to read and search.

- Program with single key inputs. No mouse required.
- Use the cross reference popup function to check a bit or output's ON/OFF status in real time.
- When the program is input, the software automatically performs a circuit check and output-duplication check to prevent input mistakes.
- With one keystroke, jump to a desired location in the program from the search results or program check results displayed in the output window.
- Input various comments (such as rung comments, I/O comments, and circuit comments) to make the program easier to read and search.

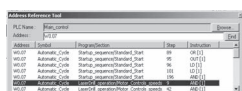

**Cross reference popup**  
Displays the real-time status of the bit or output at the cursor location. It is also possible to jump to the displayed location.

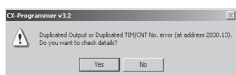

**Output duplication check**  
A output-duplication check is performed automatically when the program is input. Relevant locations are listed and it is possible to jump to those locations.

**Rung comment list**  
The rung comment jump function makes the program easier to search.

**Circuit comment, circuit comment list**  
Circuit comments can be displayed or hidden. Comments attached as notes can be checked when necessary.

**I/O comments**  
It is possible to display/hidden the I/O comments and set attributes such as the number of displayed lines.

**Rung comment list/jump**  
Program contents can be checked in a list like a table of contents. It is possible to jump to a listed location.

### Displaying Comments at the Cursor Position

The symbol comment at the cursor position and corresponding address are displayed at the bottom of Ladder View to improve program legibility.

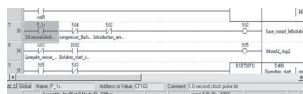

### Switching between Multiple Comments

Multiple symbol comments (up to 16) can be registered for a single address. This function enables different comments for a single program—for designing, factory, each engineer, or each language—and makes the program easier to understand for the corresponding purpose.

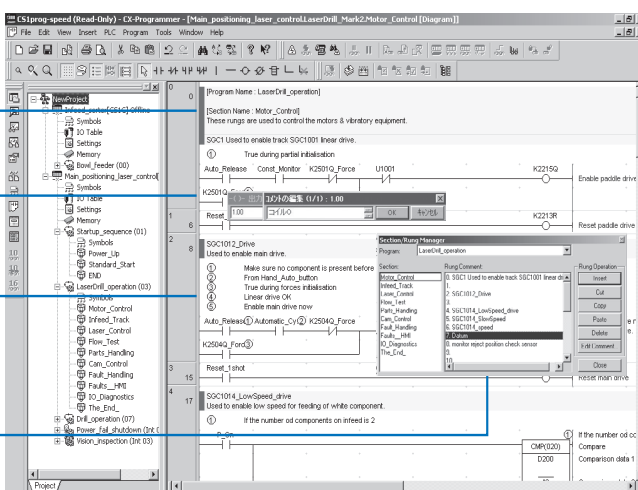
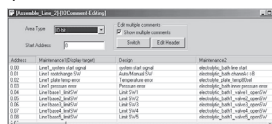

Software

Display Special Instructions Vertically or Horizontally

The user can select whether to display special instructions vertically or horizontally, improving display and printing efficiency.

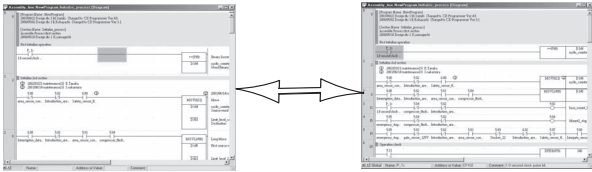

Complete Help and Guidance Functions

The help and guidance function provides helpful support when inputting or creating a program.

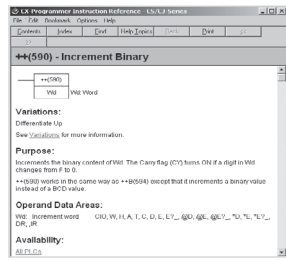

Complete instruction help  
The help function can be checked immediately when inputting instructions.

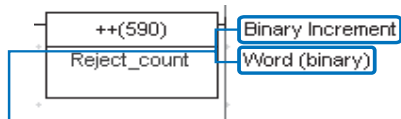

Instruction name and operand description  
The instruction name and operand meaning can be displayed in the Ladder Window. (These displays can also be hidden.)

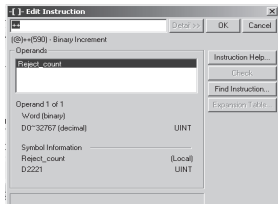

Input help function (Details dialog)

Information on the operand's allowed data areas and setting ranges can be displayed immediately.

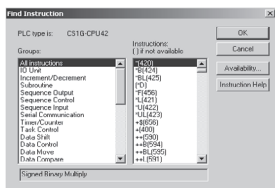

Inputting instructions by instruction group  
Instructions can be selected from a list organized by instruction functions.

Program Structure

Detailed Debugging can be performed while displaying the overall program flow.

Overall program section displays can be further divided when creating or displaying the program. In the following example, the program is created in sections based on processing and it is possible to jump to a specified processing program (section) from the section list.

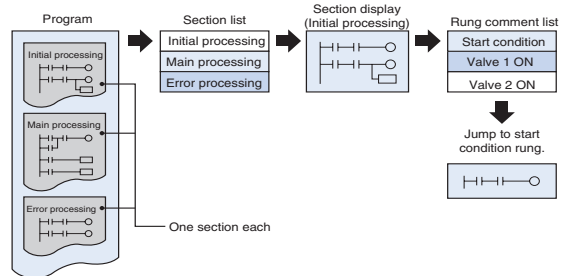

It is possible to jump to a specified section while viewing the overall program in a section list.

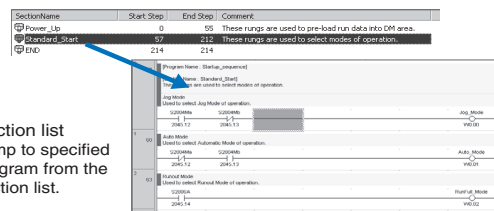

Section list  
Jump to specified program from the section list.

Sectioning Program and Reusing Sections

Sectioning Program → Reusing Sections

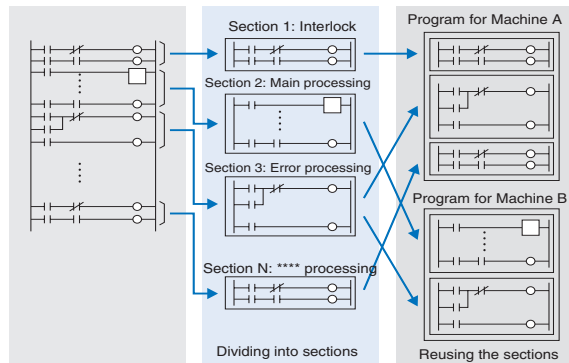

Improved Ladder Program Reusability

Parts of the program can be saved or additions can be loaded in section, ladder rung, or symbols table units. This allows programs to be easily split into smaller parts, and then integrated, thereby improving reusability of the program.

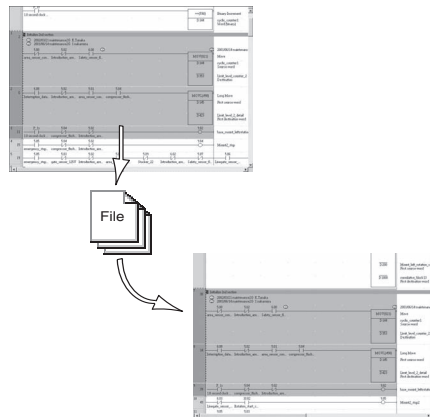

## Online Debugging

### A Complete Set of Debugging Functions reduces Debugging Time.

- Trace-back searches (searching for bits/outputs with the same address) and consecutive address searches can be performed with a single keystroke.
- Enter the search item by dragging and dropping the item in the ladder window.
- Different parts of the ladder program can be monitored simultaneously with a 2-way or 4-way split screen.
- The I/O monitor function can group locations being monitored, such as steps and processes that are being debugged.

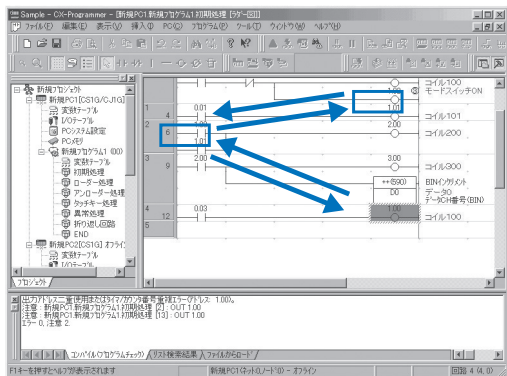

#### Trace-back Search

Search for the output corresponding to the bit address at the cursor location or search for the bit corresponding to the output at the cursor location.

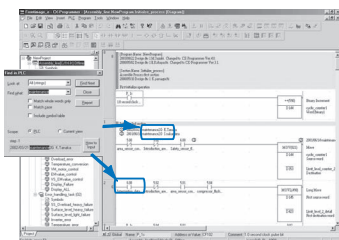

"All" has been added as a target of searching. Any strings can be entered as a keyword for searching.

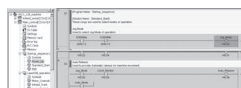
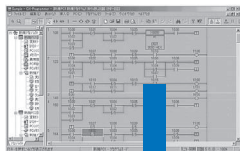

#### 2-way or 4-way Monitor

Powerful split-screen monitoring function allows simultaneous monitoring of different parts of the ladder program, an overview and detailed view of a ladder program rung, etc.

PLC Name	Name	Address	Data Type/Format	Value	Comment
PLC_monitor	SD009n	SD011	BOC (Dry-Contact)	0	Select Dry Mode
PLC_monitor	SD009n	SD012	BOC (Dry-Contact)	0	Select Automatic Mode
PLC_monitor	SD009n	SD013	BOC (Dry-Contact)	0	Select Manual Mode
PLC_monitor	SD009n	SD014	BOC (Dry-Contact)	0	Select Stop Mode
PLC_monitor	SD009n	SD015	BOC (Dry-Contact)	0	Select Emergency Stop Mode

#### I/O Monitor Function (Watch Window)

- Group different locations that need to be monitored for each process or piece of machinery being debugged.
- Various data displays are available, such as decimal, hexadecimal, signed, and floating-point.
- Registered addresses can be sorted and monitored.
- Registered addresses are automatically saved to a file. It isn't necessary to register the addresses again the next time debugging is performed.

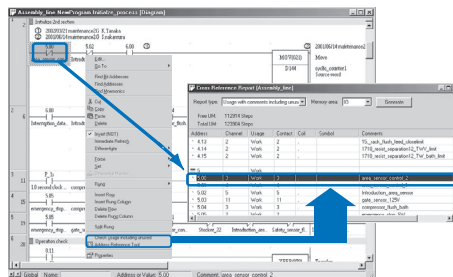

#### Easily Search Usages Overview on Ladder Diagrams

The usage overview can be launched from the a popup menu or Ladder View. This enables the user to easily check the usage of addresses at the cursor position and to easily check the usage of contacts/coins.

#### Automatic Online Connections to PLCs make Online Monitoring Easy

The CX-Programmer automatically detects the PLC model, uploads the PLC program and various parameters, and starts the ladder monitor function.

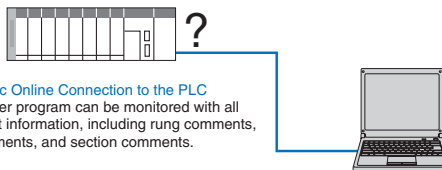

#### Automatic Online Connection to the PLC

The ladder program can be monitored with all comment information, including rung comments, I/O comments, and section comments.

#### Online Debugging Functions

- Check continuity efficiently with the ladder wrap-around monitor.
- The online editing function allows several consecutive rungs to be edited at the same time.

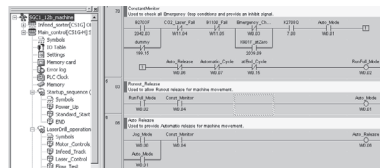

#### Ladder Wrap-around Monitor

Long ladder rungs are wrapped around to another line before connecting to the right bus bar.

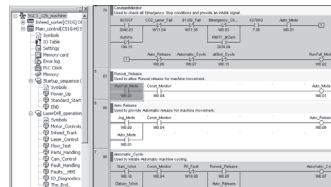

#### Online Editing

Consecutive ladder rungs can be edited together online. Before edited contents are written to the PLC, a program check is performed automatically and the results are displayed.

#### Simultaneous Online Debugging by Several People

Program development and online debugging can be performed by two or more people at the same time, so debugging time can be reduced dramatically.

#### Program Development by Several People

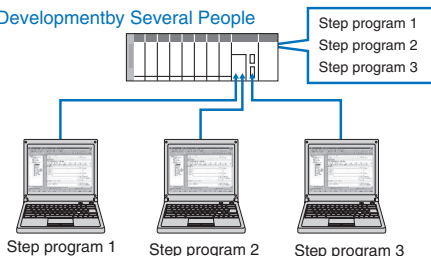

PLC Programming

# CX-Simulator

## Online debugging of virtual PLCs in the computer

Simulated ladder program execution in a virtual CS/CJ series PLC

Allows program debugging in a single PLC before the actual system has been assembled.  
Reduces the total lead time required for machine/equipment development and startup.

### Key Features

A debugging environment equivalent to the actual PLC system environment can be achieved by simulating the operation of a CS/CJ Series PLC with a virtual PLC in the computer. CX-Simulator makes it possible to evaluate program operation, check the cycle time and reduce debugging time before the actual equipment is assembled.

### Ladder program debugging in a computer

#### Monitor and debug program execution without the actual PLC.

The developed program can be executed in a virtual PLC within the computer and debugged with the CX-Programmer, just like the actual PLC.

- All of the debugging functions can be used, including the ladder monitor, I/O monitor, online editing, force setting/resetting bits, differential monitor, and data tracing.
- The cycle time can be checked without the actual PLC system.
- Interrupt tasks can also be started.

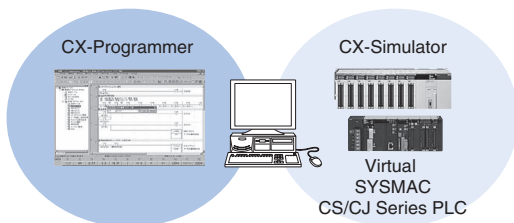

#### Execute just the required parts of structured/sectional programs and monitor the status of I/O.

Perform efficient debugging operations that cannot be performed in the actual PLC, such as executing single steps, executing single cycles, and inserting break points.

- With the step execution and cycle execution functions, the contents of I/O memory can be monitored in the middle of program execution or after execution of a single cycle.
- Program execution can be stopped when I/O memory data satisfies preset conditions, so that the I/O memory data at that point can be checked.
- A starting point and break point can be specified to execute and debug just that part of the program.



#### Debug Console

Various execution methods can be selected, such as step execution and cycle execution.

Task Control						
Tasks						
All tasks						
Type	T	Trigger	Time	Status	C.	Exec. time
Cyclic	1	Cyclic		READY	0	0.0000 ms
Cyclic	2	Cyclic		READY	0	0.0000 ms
Cyclic	7	Cyclic		READY	0	0.0000 ms
Interrupt	1	Pow...		--	0	0.0000 ms
Interrupt	3	Interval	10ms		0	0.0000 ms

#### Checking execution times

The virtual cycle time can be checked in advance. Each task can also be started and stopped and each task's cycle time can be checked.

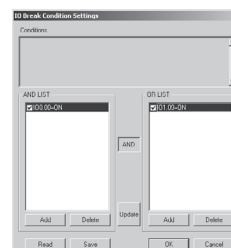

#### I/O Break Condition Settings

Stop program execution when the specified I/O memory conditions are satisfied, so that the contents of I/O memory at that point can be checked easily.





**Virtual External Inputs**

Several methods can be used to create and replay virtual external inputs.

The operation of equipment and machinery can be simulated in the PLC as virtual external inputs from several sources.

- **Reproducing Virtual External Inputs**  
When I/O memory data satisfy preset conditions, specified I/O bits and words can be set to desired values after a set time delay (I/O Condition Tool).
- **Reproducing External Inputs**  
Virtual external input data from various sources can be reproduced in the virtual PLC. (Some data sources are operation logs of force-set/force-reset bits and changed I/O memory data, data trace data acquired from an actual PLC, and cyclic data files created in spread sheet software.)

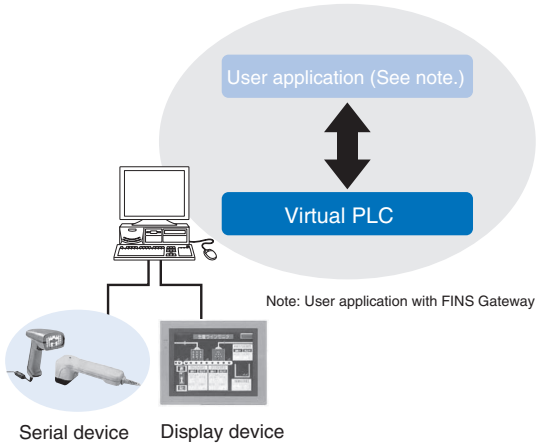

I/O Condition settings

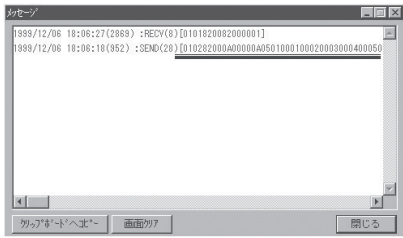

Message communications display function

**Complete Debugging with Peripheral Devices**

Total system debugging can be carried out by performing communications tests with peripheral devices (serial devices, displays, etc.) and user applications that communicate with the PLC.

- Communications can be debugged with external serial devices connected to the computer's COM port.
- Communications can be tested with Programmable Controllers through NT Link.
- Messages sent by the network communications program can be checked. Messages (frames) sent by the TXD (TRANS-MIT), SEND/RCV (NETWORK SEND/RECEIVE), and CMND (DELIVER COMMAND) instructions can be displayed at the computer.

PLC Programming

# CX-Protocol

Create serial communications protocols to communicate with standard serial devices

Easily configure serial communications protocols for any devices without complex ladder programming.

Key Features

The CX-Protocol software creates data communications procedures (protocol macros) to exchange data between standard serial devices and the PLC (Serial Communications Unit or Board).

What is a Protocol Macro?

A protocol macro defines the communications protocol for communications between the PLC and any serial device that has an RS-232C port or RS-422A/RS-485 port and uses half-duplex or full-duplex communications with start-stop synchronization. Serial communications can be processed without a ladder program routine once the protocol macro has been written to the Serial Communications Unit or Board (CS/CJ Series Unit/Board, C200HX/C200HG/C200HE Board, or CQM1H Board) and the PMCR instruction has been executed from the CPU Unit's ladder program.

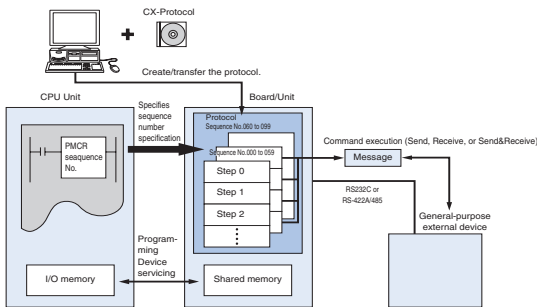

Overview of Protocol Macros

The protocol macro function can be broadly divided into the following two functions.

1. Creation of communications frames (messages)
2. Creation of procedures to send/receive those communications frames (messages)

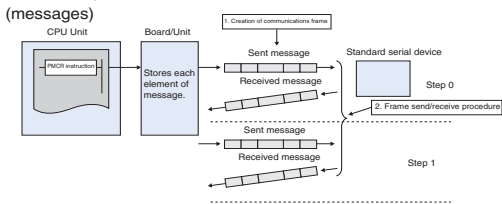

1. Creating communications frames (messages)

1) Communications frames (referred to as "messages" here), which can be understood by general-purpose external devices, can be created according to the communications specifications.

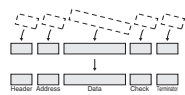

Note: In general, the data area of a send message contains a command code and data. The data area of a receive message contains a response code.

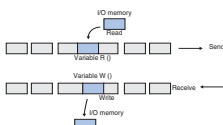

2) Variables for reading data from (or writing data to, if receiving) the I/O memory data areas in the CPU Unit, can be integrated into the messages.

This function has the following advantages:

- Ladder program processing will not be necessary at the CPU Unit when, for example, sending messages after arranging them all in data memory.
- The components of the previously created messages are stored in memory at the Unit or Board, not the CPU Unit. When sending or receiving data, the CPU Unit only has to execute the PMCR instruction.
- When handling one part of the I/O memory data, if the variable required for reading that data has been integrated into a send message, the Unit or Board will automatically read the required data from the I/O memory of the CPU Unit when the PMSU sends the message. Similarly, when writing data from one part of a received message into I/O memory, if the variable required to read the data has been integrated into the reception settings message, the Unit or Board will automatically write the data at the designated position in the message into I/O memory when the Unit or Board receives the message.

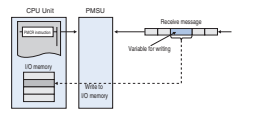
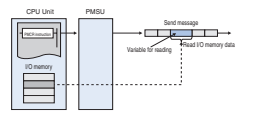
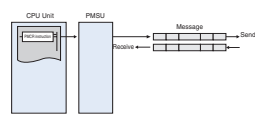
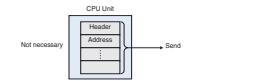

2. Creating procedures to send/receive the communications frames (messages)

1) This function enables all the processing needed to send or receive a message to be handled as one step, and possesses all the commands (step commands), such as Send, Receive, Send&Receive and Wait, that are needed for each step.

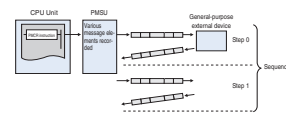

2) This step can be set so that the next process (step/end) depends on the processing result of the previous step. In particular, it is possible to set the sequence so that the next process depends on the contents of one or several set receive messages.

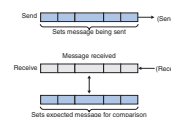
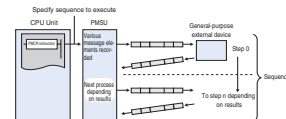

Note 1: A send message created with a protocol macro will perform settings for messages that are actually sent.

Note 2: A receive message created with a protocol macro will set an expected message for comparison with messages that are actually received.

## Developing Communication Protocols

### Supports a Wide Range of Communication Protocols

- Send frames and receive frames can be created according to the communications frame (message) specifications of external devices. In addition, variables for exchanging data with the PLC can be incorporated in send and receive frames.
- Supports error check code calculation, frame length calculation during transmission processes, and numeric data conversion between ASCII and hexadecimal.
- Repeat variables can be used, 1:N communications are supported, and write destinations can be switched.
- Supports send and receive time monitoring functions as well as retry processing, so the required communications error processing can be specified easily.
- The interrupt function can send an interrupt to the CPU Unit when receiving data, so high-speed data processing can be performed.
- Expected reception data can be registered and processing can be switched based on the received data.

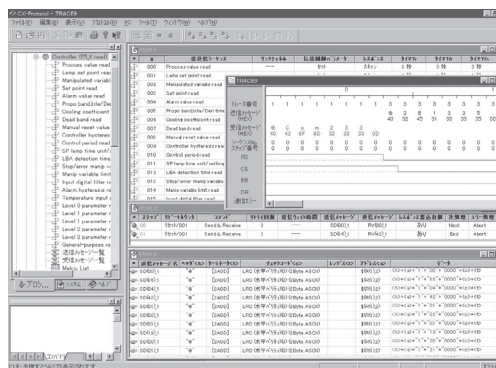

## Complete Set of Debugging Functions

### Sequences can be evaluated, saved, and printed with send/receive message tracing.

- Trace function  
With a CS/CJ Series PLC, up to 1,700 characters of time-sequential transmission or reception data, which the Board or Unit exchanges with external devices, can be traced. Tracing allows the user to determine which messages were transmitted or received in each step number. The results of tracing can be saved as data in project files or printed.

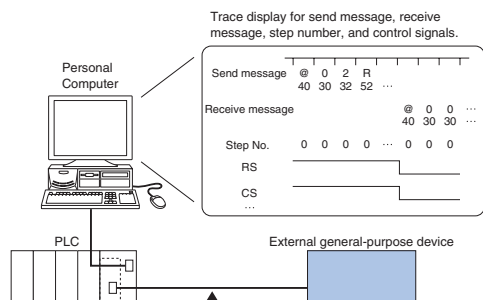

- I/O memory monitor function  
Send/receive data stored in the PLC's data areas can be monitored.

Connected component	Model	Send/receive sequences	
CompoWay/F Master	OMRON components equipped with CompoWay/F Slave functions	Sending CompoWay/F commands and receiving responses	
Controllers/ Temperature/ Controllers	Small Digital Controller with Communications Functions (53 x 53 mm)	Present value read, set point read, manipulated variable read, etc. Set point write, alarm write, PID parameter write, etc.	
	Temperature Controllers with Digital Indications (96 x 96 mm or 48 x 96 mm)		
	Digital Controllers with Communications Functions (96 x 96 mm)		
	High-density Temperature Controller with Communications Functions		
Digital Panel Meters with Communications Output (custom specification)	K3T□	Display value read, comparison value read, write, etc.	
Bar Code Readers	Laser Scanner version	V500	Read start, data read, read stop, etc.
	CCD version	V520	
Laser Micrometer	3Z4L	Measurement condition set, continuous measurement start, etc.	
Machine Vision Systems	High speed, high precision, low cost version	F200	Measurement, continuous measurement, etc.
	High-precision Inspection/Positioning	F300	
	Character Inspection Software/ Positioning Software	F350	
ID Controllers	Electromagnetic coupling	V600	Carrier data read, autoread, write to carrier, etc.
	Microwave	V620	
Hayes modem AT command	MD24FB10V MD144FB5V ME1414B2	Initialize modem, dial, transfer data, etc.	

## Standard System Protocols

### Protocols to exchange Data with OMRON Control Devices area Standard Feature.

Data exchange protocols for 13 kinds of OMRON control devices, such as Temperature Controllers and Bar Code Readers, are provided. The standard system protocols can be copied easily and customized.

Motion

# CX-Motion

**Creates programs to control the motion controller and monitors controller status**

Provides the ideal environment for motion control support, from motion controller program development to full system operation.

**Key Features**

The CX-Motion software can be used to create, edit, and print the various parameters, position data, and motion control programs (G code) required to operate Motion Controllers, transfer the data to the Motion Control Units, and monitor operation of the Motion Control Units. Increase productivity in every step of the motion control process, from development of the motion control program to system operation.

**Motion Control Programs**

Easily create motion control G Code programs and parameters.

CX-Motion can create all of the data needed in the Motion Control Unit, such as parameters, position data, and the program. The program can be input in either G code or mnemonics.

- When the Unit is connected online, data can be transferred, verified, and saved.
- Data for different Units can be registered and managed as separate projects.

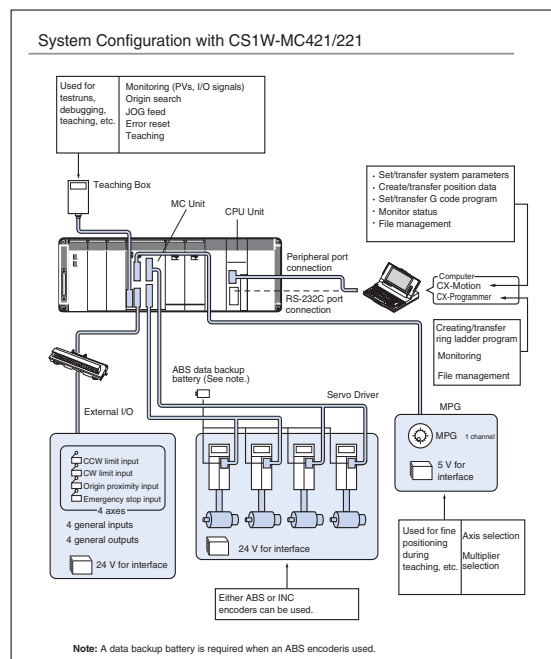
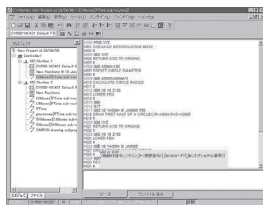

**Operation Monitor**

Powerful support during startup and operation

The MC Unit Monitoring function can display vital information at the computer, such as the present position, task being executed, I/O status, error displays, and servo system trace data.

- Up to 20 errors that have occurred in the Motion Control Unit can be stored and displayed (CS1W-MC421/221 and CV500-MC421/221 Motion Control Units only).

**Automatic Loading Function**

Ideal for flexible, small-lot production lines

Various programs and position data can be stored on disks for the computer running the CX-motion software and the required program/position data can be substituted into the Motion Control Unit when necessary. More than 100 different application programs can be used in this way. A wide variety of programs can be available for execution if the computer is used to store data for the MC Unit.

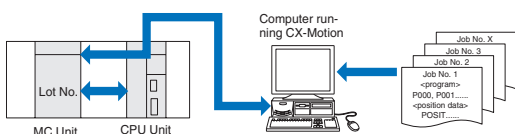

Motion

# CX-Position

Set, transfer, store, and print position control unit data and monitor operation online

Increase productivity in all position control tasks, from design and startup to system maintenance.

**Key Features**

The CX-Position software simplifies every aspect of position control, from creating/editing the data used in Position Control Units (NC Units) to communicating online and monitoring operation. The software is equipped with functions that can improve productivity, such as automatically generating project data and reusing existing data.

**Creating and managing data**

Data can be created for various applications

The CX-Position enables data for multiple NC Units on up to 1,000 PLCs to be handled as 1 project. Data is displayed in tree format and the data for an NC Unit can be moved or copied (overwritten) between PLCs in the project tree. This feature allows data to be edited and re-used in other PLCs or NC Units.

- The CX-Position can read information from NC Units connected online and automatically generate project data.
- Data created for a C200HW-NC□□□□ using the SYSMAC-NCT can be imported and used as data for the CS1W-NC□□□□ or CJS1W-NC□□□□.

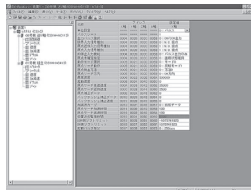

**NC Monitor**

Display the NC units' present positions, error codes, sequence numbers, and I/O status.

The sequence numbers and present positions can be displayed for up to 4 Units. In addition, the contents of the operating memory area and operating data area can be monitored and the error log can be displayed.

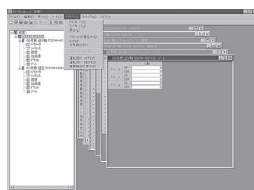

**Communications**

Communicate with NC units through the network.

It is possible to communicate with NC Units through the Fins-Gateway. Depending on the FinsGateway driver version, HostLink or Ethernet. can be used to perform online operations (monitoring operation or transferring/verifying parameters, sequences, etc.) with the NC Unit.

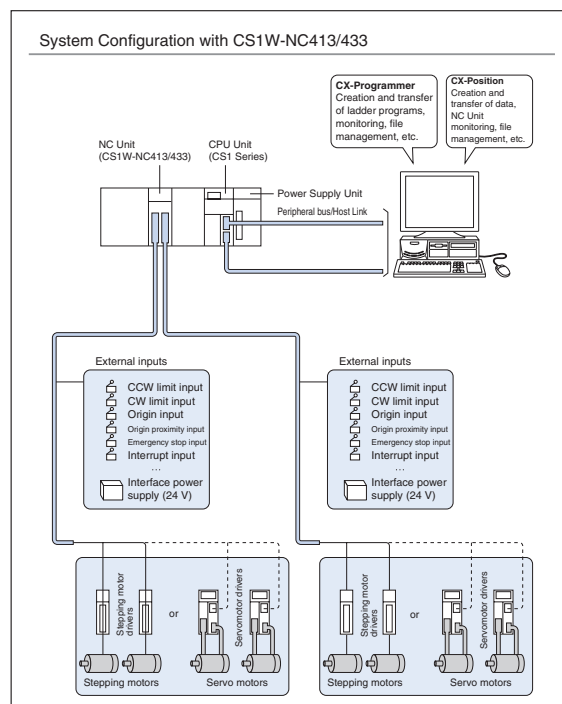

Motion

# CX-Motion NCF

**Configures mechatrolink II network**

**Provides easy configuration for the mechatrolink II network and devices on the network**

**Key Features**

Since the actual motion programming for the NCF unit is created in the PLC (using either the Omron library of "PLC-Open" motion function blocks or customer specific function blocks) the NCF software is used to easily configure & monitor the mechatrolink II network and the devices installed on the network.

**Mechatrolink network configuration**

Configuration of mechatrolink networks allows easy creation of devices & ability to copy & paste to reduce development effort.

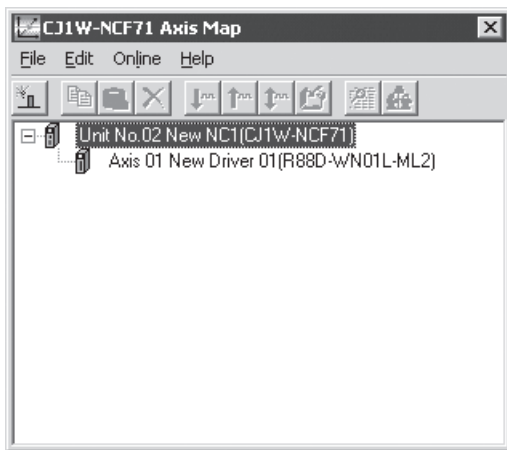

**Mechatrolink network monitoring**

Monitoring of network and devices to allow fast fault-finding and easy maintenance of network based motion control systems.

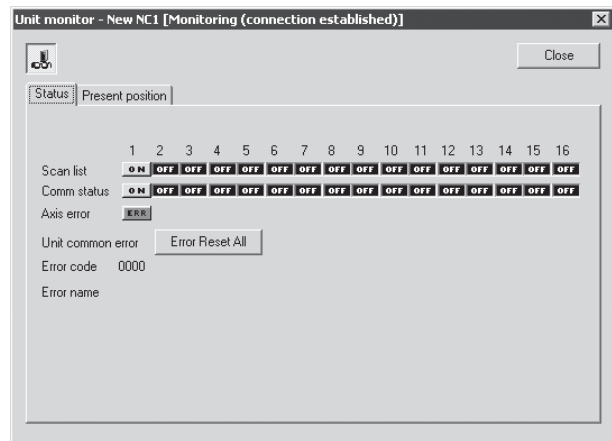

**Device configuration**

Allows detailed configuration of the parameters of all devices on the mechatrolink II network.

- Device configurations can be copied and pasted to reduce development effort
- Exported to CSV file

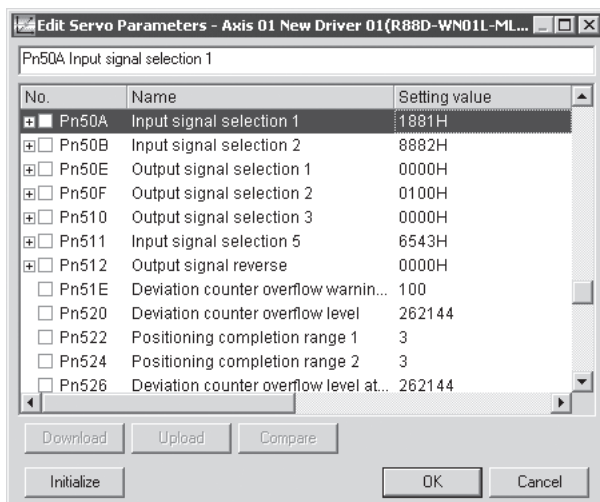

**System configuration with CJ1W-NCF71**

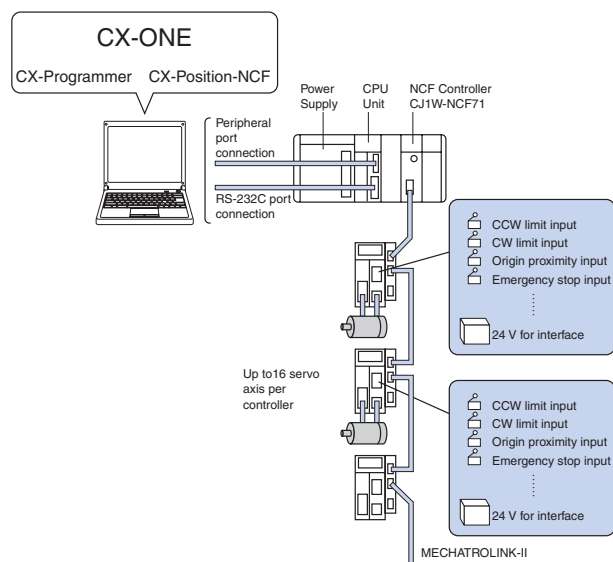

Motion

# CX-Motion MCH

Reduce the complexity of advanced motion control.

Programming and configuration for Mechatrolink II based MCH motion controller.

### Key Features

Create powerful motion solutions quickly using this integrated configuration and programming software for Mechatrolink II based systems.

#### Mechatrolink and device configuration

Configuration of Mechatrolink networks allows easy creation of devices and the ability to copy&paste configurations to reduce development.

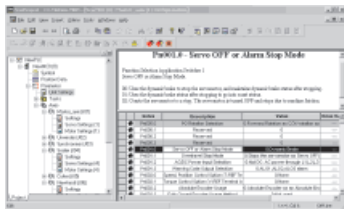

#### System configuration

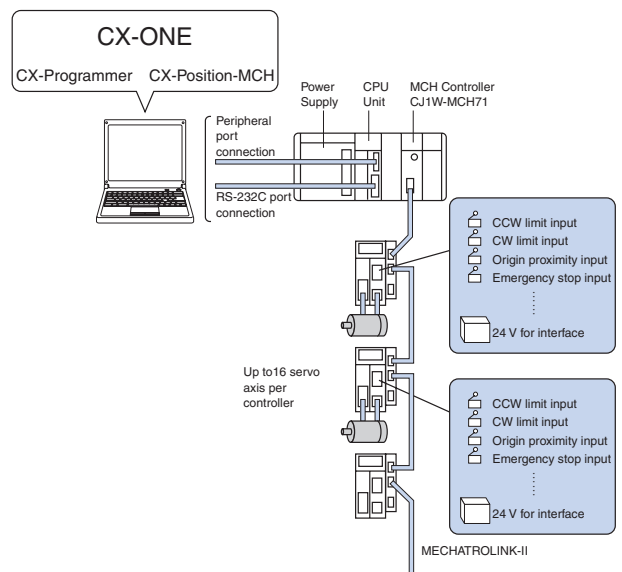

#### Motion programming

Easy programming using a familiar 'workspace editor' to allow easy representation of all configurations and programming for each MCH unit.

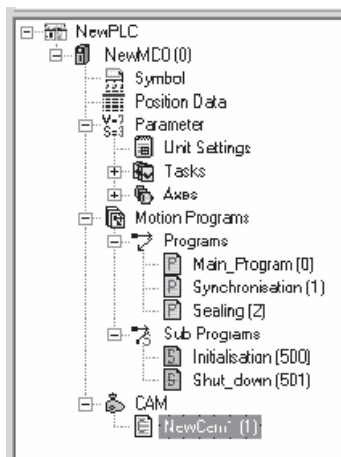

Each MCH supports up to 32 axis of motion, to allow easy programming the programs can be split into 'Main' and 'Sub' programs. These program modules can easily be imported and exported to other projects, or to libraries to reduce the total development time.

Programming is carried out using standard 'Basic' type of language to allow easy creation of programs. A common symbol table also allows easier programming of larger systems.

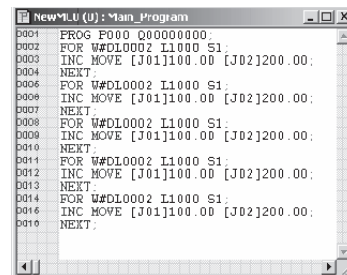

Specific instructions allow key motion functionality to be used easily. CAM profiles are also integrated into MCH software and are created by importing the CAM able information from a CSV file, typically created from excel or CAM creation software.

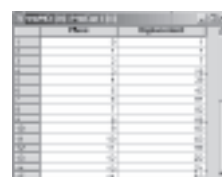

Software

Motion

# CX-Drive

## One software tool for inverters & servos

reduce the time and complexity of configuring, commissioning and maintaining servos or inverters with a single software tool.

### Key Features

#### Programming

The complete current range of Omron Yaskawa inverters and servos is covered in this software with full access to all parameters (with 3 different operator levels available). An easy overview of parameters is also included which includes filters to show values that are:

- Different from default
- Different from inverter
- Invalid setting

Graphical overviews are available to further assist with configuration of some more detailed parameters such as jump frequencies, v/f profiles and analogue setting.

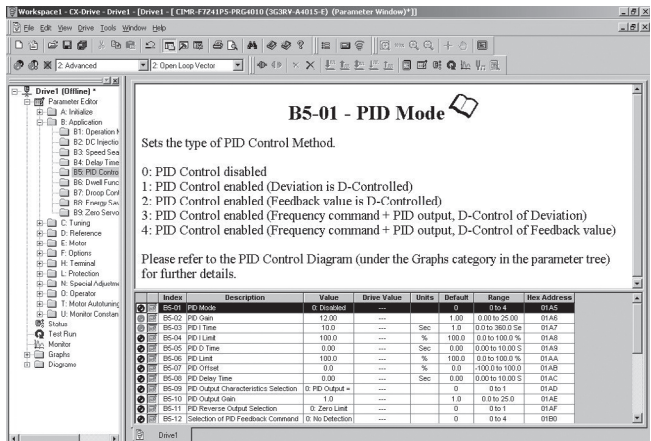

#### Commissioning and Maintenance

To increase the ease of maintenance, connection can be either directly to the device, through PLC, across networks or remotely via modem. Specific 'test run' windows are offered to graphically represent inverter settings to allow easy optimisation of settings.

A monitoring window allows multi-traces with separate scaling and offset for each trace, and combines powerful triggering options and the ability to save/review trace files. These features allow you to precisely monitor inverter and servo performance during the test run, commissioning, and maintenance phases. The status and configuration of the digital I/O can also be graphically displayed to allow easy 'at a glance' setting and monitoring.

CX-Drive is part of the Omron CX-software suite and uses a common communications platform, called CX-Server. This allows a single point multiple access to all configurable Omron components on your machine for programming, configuring or monitoring. Inverters or servos can be accessed across network or through other devices such as Programmable Logic Controllers. This single connection point can be serial, network or modem, so allowing complete remote access to components such as inverters and servos of the whole machine from anywhere in the world!

#### Products covered

Inverters	MV (V7) E7 F7 L7
Servos	R88D W-series Smart Step SGDH SGDH-Linear

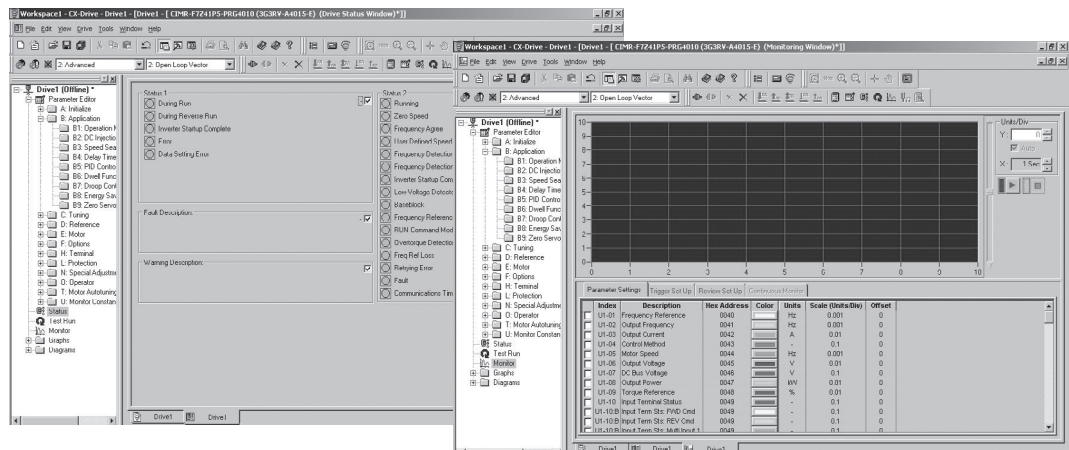

Order code	
CX-Drive	One software tool for inverters & servos



# Regulation CX-Process Tool

Creates, transfers, runs, and debugs function blocks for loop control units/boards.

Easy Engineering Solutions for advanced PLC based process control

### Key Features

The CX-Process Tool software simplifies every aspect of loop control, from creating/transferring function blocks to running the Boards/Units and debugging (tuning PID parameters, etc.) operation.

### Creating Programs

Function Block Diagrams can be created easily.

Function block programs can be created easily by pasting function blocks in the window and making software connections with the mouse.

- Control Blocks, Operation Blocks, and Field Terminal Blocks are available, so all of the required functions can be performed just by arranging the function blocks.
- Comments (user-set character strings) can be pasted in the function block diagrams.

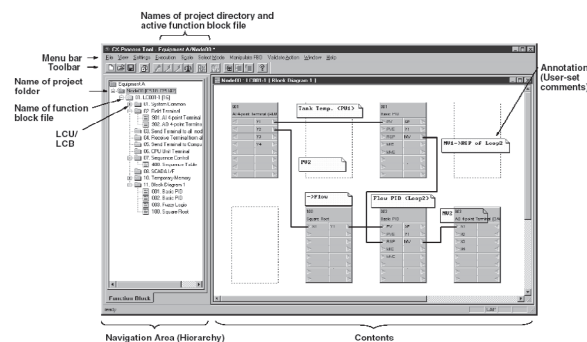

### Debugging

Operation can be checked and tuned easily.

All of the ITEM data in a block can be monitored and the operation of a function block's connections can be checked. The PV, SP, and MV trends can be monitored and adjusted in the Tuning Screen.

- A function block's analog signal values can be displayed and forcibly changed and the operation of each function block can be stopped and re-started.
- Run/Stop commands can be executed (Hot or Cold Start).

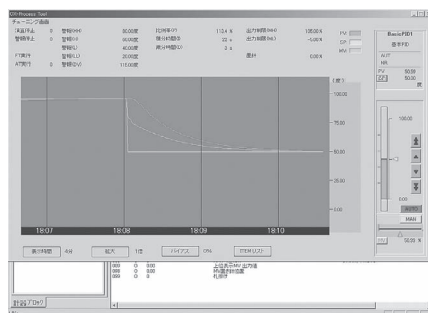

### Transferring Programs

Programs can be changed Online.

The entire program, individual blocks, and individual ITEMS can be downloaded from or uploaded to the LCU/LCB.

- When there is a change in an individual block or ITEM, the change can be made while the LCU/LCB continues running.
- Block diagram information can also be downloaded/uploaded (LCU version V2 or higher only).

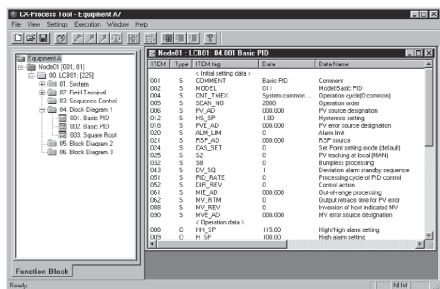

Regulation

# CX-Thermo

**Monitoring/setting support software for E5CN- and E5ZN-series Temperature Controllers providing easy setup, online data logging, and realtime monitoring.**

- Enables creating, editing, and batch-downloading parameters from a personal computer, reducing the work required to set parameters
- Support Online Monitoring: Monitoring data for up to 31 Temperature Controllers at the same time (The Temperature Controllers must be from the same series.)
- Supports parameter masks for hiding unused parameters (E5CN only).

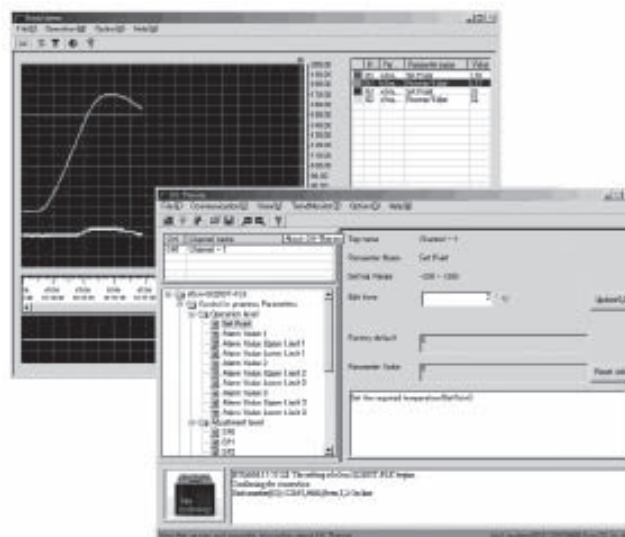

### Main features

- New parameter configuration software for temperature controllers.
- Off-line configuration mode with full upload and download capability.
- On-line monitoring of setpoint, process value, manipulated value and multi-point value on your PC
- Sophisticated live logging and trending facility for testing and recording key parameter values
- Multi-drop capability.
- File handling to save instrument configurations in several different file formats.
- Besides Auto-tuning also a "personal" Fine-tuning facility for optimisation according to your specific process response preferences.

### Other features

- Remote configuration of multiple controllers and intelligent signal processors in an easy-to-use Windows based package.
- Comprehensive help system, including introduction to the Omron Control Components.
- CX-Thermo can connect to the E5ZN and next E5CN temperature controllers. In the near future the new E5AN/E5EN and E5□R will be supported as well.

### Specification

Supported products	E5ZN E5CN E5AN E5□R
Connections	Direct serial (1:1, 1:N), modem, GSM modem, through Omron PLC

### List of Models

Model	Name
EST2-2C-MV1	CX-Thermo Support Software

**Note:** The old models of E5CN Temperature Controller (manufactured in March 2004 or earlier) are not supported.

# CX-Designer

Efficient development process for screen creation, simulation and project deployment.

The CX-Designer is used to create screen data for NS-series Programmable Terminals. The CX-Designer can also check the operation of the created screen data on the computer.

## Screen Creation

Develop Screens More Efficiently with Easy-to-use Support Software. The CX-Designer has about 1,000 standard functional objects with associated graphics and advanced functions, so even first-time users can create screens easily just by arranging functional objects in a screen.

The CX-Designer is also equipped with a variety of functions that make it easy to create screens for common applications. Screen development is far more efficient with the CX-Designer.

- Color Change when the Upper or Lower Limit Is Exceeded

The upper limit can be monitored just by checking the box and setting the upper limit value.

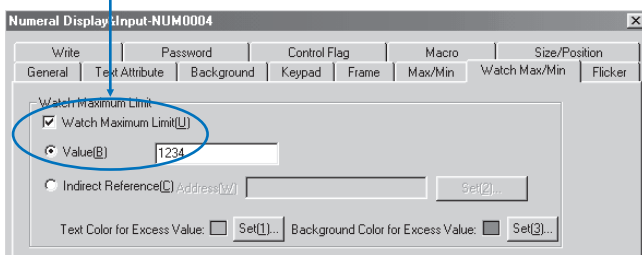

- Indirect Specification of the Display Color (Dynamic Display) with the Color Code (0 to 255)

The color can be specified indirectly by checking the box and setting the address being used for indirect specification.

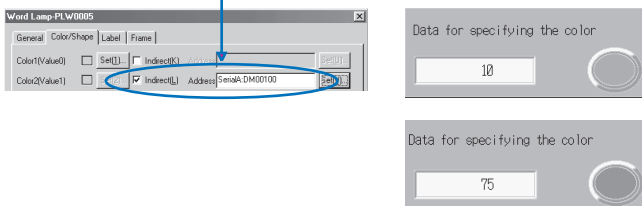

- Flow Text Display for Alarm/Event Messages

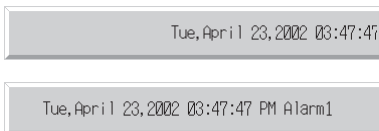

## Screen templates

Make one common screen (sheet) that overlaps other screens (to save having to recreate the same part, such as a menu, in every screen).

- Sheets

A feature that is common to several screens can be registered as a sheet. The common feature can be added to any screen just by applying the corresponding sheet to the screen. (Up to 10 sheets can be created for one project.)

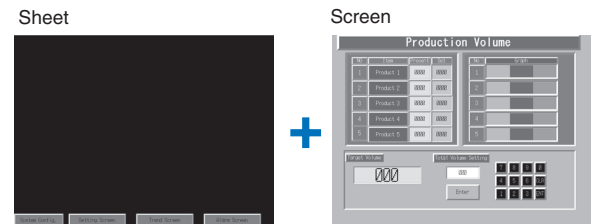

Resulting screen with sheet applied

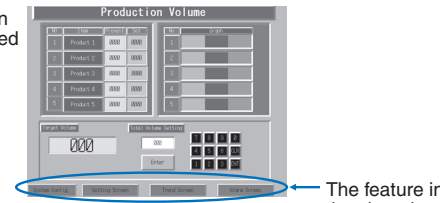

The feature in the sheet is added.

## Making Table Form Objects

Speed up creating tables containing similar functional objects.

- Tables

The same kind of functional objects (such as Buttons, Text, or Numeral Display & Input objects) can be created together in a table just by specifying the kind of functional object, number of rows, and number of columns in the table. In addition, the properties for functional objects can all be set together and PLC addresses can be allocated automatically.

It is also possible to add headings for each row and column.



Create the table by specifying Numeral Display & Input as the functional object, 4 rows, 4 columns, and headings (text).

Settings such as the headings

	Operational Setting	Passing Setting	Preparation	Process
Product A	00	00%	0min	0hr
Product B	00	00%	0min	0hr
Product C	000	00%	0min	0hr
Product D	00	00%	0min	0hr

**The Operation of Screen Data Can Be Confirmed Easily on a Personal Computer**

Check the operation of functional objects (buttons, lamps, numeral displays, etc.) on a personal computer.

- Simulation via the “Test Function”

When a test is started, a test screen and virtual PLC will be displayed on the computer.

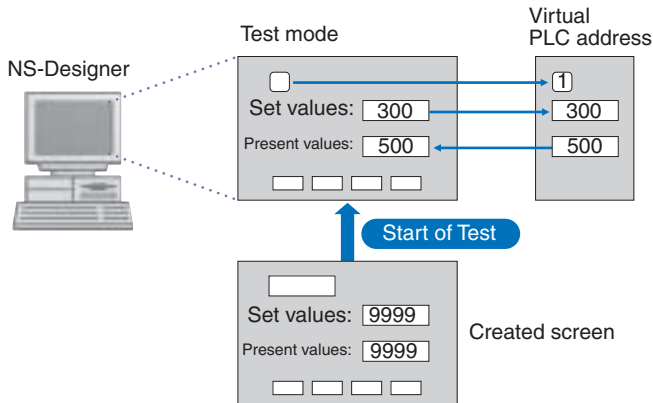

Operating (clicking with the mouse) the functional objects on the test screen will change the corresponding address in the virtual PLC. Conversely, changing the content of a virtual PLC address will change the corresponding functional objects. It is also possible to confirm pop-up screens. This function can be used to confirm the actual operation of a screen during the edition.

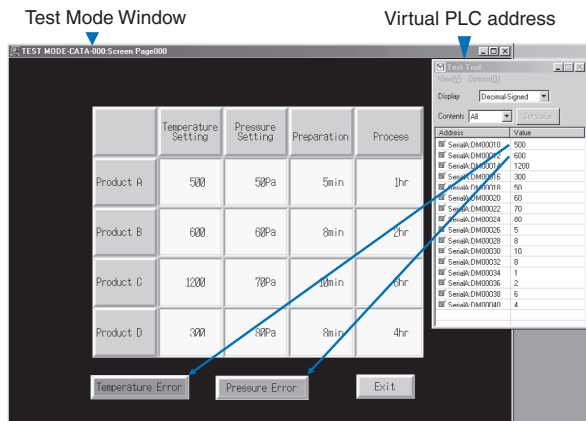

The test function enables debugging screens without NS and PLC Hardware.

- Validation

Validation checks functional objects against checkpoints (such as PLC addresses setting miss), and detected errors are listed. The listed errors can be checked before transferring the screen data to the PT.

**Built-in Recipe Function for Fast Production Changeovers**

Data blocks (recipe function) allow several numeric values and/or character strings to be transferred to/from memory areas, such as PLC data areas. Data blocks can be used to change the system’s production setup even faster.

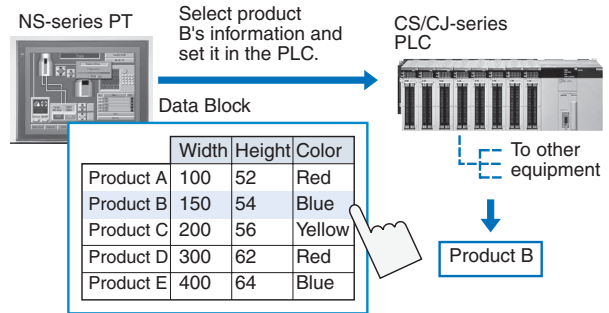

- Register Recipes Easily by Writing Product Information in Data Blocks.

The Data Block (recipe) function consists of records and fields. Set the communications address and data format for each field. The records contain the data for each field.

For example, when production conditions are assigned to the fields, write the values for the product in that record so that the values required for production of the product will be transferred to the PLC.

Using this function can drastically reduce the time required to switch the production arrangement. This function also helps avoid production problems from errors such as recipe transmission mistakes.

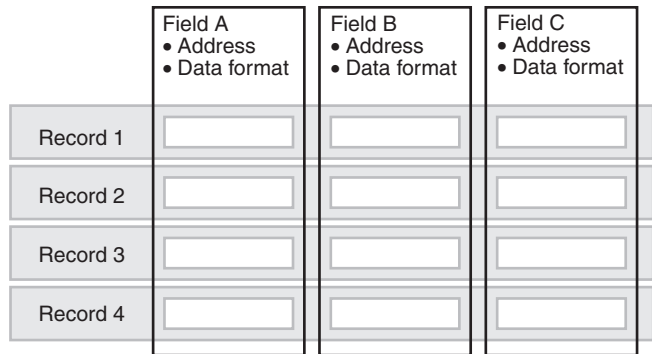

PROFIBUS configurator

# CX-PROFIBUS

## Advanced configuration tool that uses FDT/DTM (Field Device Tool and Device Type Manager) Technology

- The PROFIBUS-DP network topology and system characteristics are defined and then downloaded in the OMRON PROFIBUS Master Unit
- Configuration can be done remotely, via other networks as Ethernet or ControllerLink
- Can be used with all OMRON masters

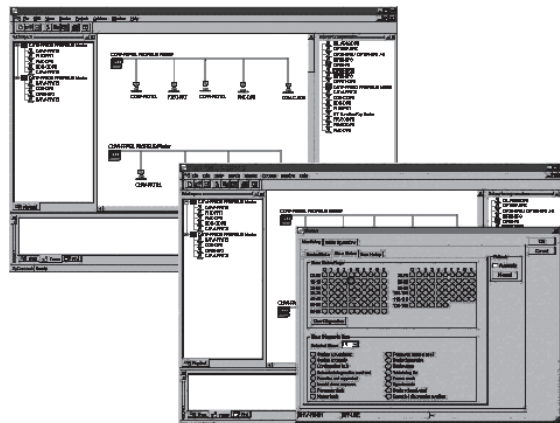

### Function

The configuration software package for the OMRON PROFIBUS-DP master is used to define:

- The configuration of the bus system connected.
- Configuration- and parameter data of all connected slave stations.
- Overall bus communication settings.

All configuration data can be prepared off-line and downloaded remotely.

After the initial configuration has been downloaded, the software package can be used for:

- Addition / deletion of slave units or -modules.
- Monitoring the PROFIBUS system status.
- Troubleshooting communication problems.

It is not possible to use other (general-purpose) PROFIBUS-DP Configurator software packages for this purpose

### More about FDT/DTM and OMRON CX-PROFIBUS

FDT is a frame application that provides a standard communication interface between software components that support the field devices and systems. These so-called DTMs, can be used in all configuration tools who follow the FDT specification.

The DTM is the management component for a field device or system. It provides all configuration, diagnostics and maintenance information and even graphical user dialogs of the specific device. OMRON's CX-PROFIBUS configuration package is a FDT frame application that includes all DTM's for OMRON PROFIBUS masters and slaves. DTM's of other vendors devices can be added. Also a Generic slave DTM for field devices that only provide a GSD-file for configuration is available.

### System Configuration

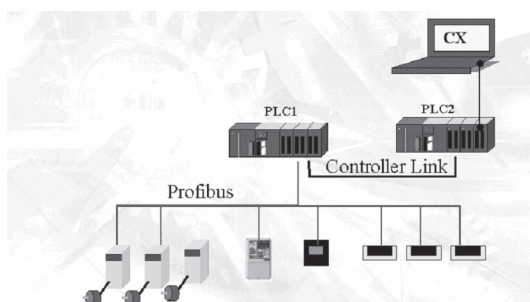

# PC Specifications

## CX-Integrator

### Specifications

Item	Specification			
Model	Provided in the CX-One FA Integrated Tool Package (CXONE-AL@@C-E).			
Setup media	CD-ROM			
Applicable computers (with FinsGateway)	Computer	IBM PC/AT or compatible		
	CPU	Pentium 133 MHz or better for Windows 98 SE or NT 4.0 with service pack 6a		
	OS	Microsoft Windows 98 SE, Me, 2000, or XP Microsoft Windows NT version 4.0 service pack 6a Note: CX-Integrator cannot be used with Windows 95.		
	Memory	64 MB min. for Windows 98 SE or NT 4.0 with service pack 6a		
	Hard disk drive	100 MB min. of available space		
	Monitor	SVGA, 800 x 600 pixels or better Note: Use the small font size.		
	CD-ROM drive	At least one required.		
	Communications port	At least one RS-232C or USB port (See note.) Note: The USB port on a computer can be connected to if the CJ1W-CIF31 USB-Serial Conversion Cable is used. (The driver software included with the CJ1W-CIF31 must be installed on the computer.)		
PLCs that can be used as relay PLC for online connections Note: A relay PLC is the PLC to which the CX-Integrator is connected online.	Series	Device type (See note.)	CPU Unit model	
	CS Series	CS1H	CS1H-CPU67/66/65/64/63(-V1)	
		CS1G/CJ1G	CS1G-CPU45/44/43/42(-V1)	
		CS1G-H	CS1G-CPU45H/44H/43H/42H	
		CS1H-H	CS1H-CPU67H/66H/65H/64H/63H	
		CS1D-H	CS1D-CPU67H/65H Note: When using a pre-Ver. 1.1 CS1D-H CPU Unit, use it as if it were a CS1H-H CPU Unit.	
		CS1D-S	CS1D-CPU67S/65S/44S/42S	
	CJ Series	CS1G/CJ1G	CJ1G-CPU45/44	
		CJ1M	CJ1M-CPU23/22/21/13/12/11	
		CJ1G-H	CJ1G-CPU45H/44H/43H/42H	
CJ1H-H		CJ1H-CPU67H/66H/65H		
Note: To connect the computer running CX-Integrator directly as a CompoWay/F slave, set the Device type to <i>CompoWay/F Device</i> .				
Connecting to the Relay PLC	Either of the following can be used.			
	Serial communications	Direction connection is possible to any of the following serial ports on a CS/CJ-series PLC. <ul style="list-style-type: none"> <li>• CPU Unit peripheral port (Toolbus or Host Link)</li> <li>• CPU Unit RS-232C port (Toolbus or Host Link)</li> <li>• Serial Communications Board or Serial Communications Unit RS-232C port or RS-422A/485 port (Host Link)</li> </ul> <b>Note:</b> Automatic online connection is possible for serial communications ports. (The user does not have to set the computer communications settings.) The communications settings will be automatically set to those of the PLC. Connection is possible to a serial port on the CPU Unit, a Serial Communications Board, or a Serial Communications Unit. For PLC serial ports, however, only the Toolbus or Host Link serial communications modes can be used and the baud rate must be 9600, 19200, 38400, or 115200 bits/s.		
FINS network communications	Direction connection is possible through any of the following networks on a CS/CJ-series PLC. <ul style="list-style-type: none"> <li>• Ethernet (Ethernet, Ethernet FINS/TCP, or FinsGateway)</li> <li>• Controller Link (Controller Link or FinsGateway)</li> <li>• SYSMAC LINK (SYSMAC LINK or FinsGateway)</li> </ul>			
PLCs that are accessible as target PLCs  Note: The target PLC is the PLC actually being accessed, e.g., to upload/download the PLC's network configurations.	Series	Device type	CPU Unit model	
	CS Series	CS1H	CS1H-CPU67/66/65/64/63(-V1)	Note: CompoWay/F cannot be used with a built-in serial port on the CPU Unit.
		CS1G/CJ1G	CS1G-CPU45/44/43/42(-V1)	
		CS1G-H	CS1G-CPU45H/44H/43H/42H	Note: A CPU Unit with unit version 3.0 or later must be used when using CompoWay/F with a built-in serial port on the CPU Unit
		CS1H-H	CS1H-CPU67H/66H/65H/64H/63H	
		CS1D-H	CS1D-CPU67H/65H Note: When using a pre-Ver. 1.1 CS1D-H CPU Unit, use it as if it were a CS1H-H CPU Unit.	Note: CompoWay/F cannot be used with a built-in serial port on the CPU Unit.
		CS1D-S	CS1D-CPU67S/65S/44S/42S	
	CJ Series	CS1G/CJ1G	CJ1G-CPU45/44	Note: A CPU Unit with unit version 3.0 or later must be used when using CompoWay/F with a built-in serial port on the CPU Unit
		CJ1M	CJ1M-CPU23/22/21/13/12/11	
		CJ1G-H	CJ1G-CPU45H/44H/43H/42H	
CJ1H-H		CJ1H-CPU67H/66H/65H		
Note: The CS/CJ-series PLC must have a lot number of 030201 or later (manufactured 1 February 2003 or later) to start the CX-Designer and transfer screen data to an NS-series PT from the CX-Designer through the PLC. The following PLCs can be used: CS1G-H, CS1H-H, CS1D-S, CJ1M, or CJ1H-H. (The CS1D-H cannot be used.)				

Item	Specification
Supported communications	The following communications are possible for a directly connected target PLC.
	Supported network communications Ethernet (Access is possible only to CS/CJ-series PLCs, NS-series PTs, and computers with FinsGateway on the Ethernet network. For CVM1/CV-series PLCs, only display functions are supported.) Controller Link (Access is possible only to CS/CJ-series PLCs, NS-series PTs, and computers with FinsGateway on the Controller Link network.) For C200H-series PLCs and CVM1/CV-series PLCs, only display functions are supported.) Note: When the Controller Link Network Diagnosis application is being used, it is possible to monitor and troubleshoot PLC models in the Controller Link network other than CS/CJ-series PLCs. SYSMAC LINK (Monitoring is possible only to CS/CJ-series PLCs, NS-series PTs, and computers with FinsGateway on the SYSMAC LINK network.) DeviceNet (CS/CJ-series DeviceNet Units, C200H DeviceNet Master Units, or CVM1/CV-series DeviceNet Master Units) Note: A C200H-DRM21-V1 or CVM1-DRM21-V1 DeviceNet Master Unit can be used through a CS/CJ-series DeviceNet Unit.
	Supported serial communications CompoWay/F (CS/CJ-series CPU Units must be unit version 3.0 or later.) Serial Communications Boards and Serial Communications Units must be unit version 1.2 or later. Only slaves for which CPS files are installed on the computer can be accessed. NT Links (Connection is possible only for NS-series PTs with model numbers ending in V1 or later.)
Note: Accessing PLC Communications Across Network Layers If relay network routing tables are set, a PLC on a different network layer than the network of the PLC connected to the CX-Integrator can be set as the target PLC.	
Online Connection Information Window	When the target PLC is online, Communications Units connected to the target PLC (referred to here as simple "Communications Units") are displayed as follows: Target Device, Target PLC CPU Unit model (network address) (node address) <ul style="list-style-type: none"> <li>• CPU Unit name [model] (network address) (-) (serial port FINS unit address)</li> <li>• Communications Unit name [model] (network address) (node address) (unit number)</li> <li>• Communications Unit name [model] (network address) (node address) (unit number)</li> </ul> Communications configuration information can be uploaded by right-clicking a Communications Unit and selecting <b>Transfer – Network to PC</b> .
Communications monitoring functions	Ethernet Node information for FINS communications (CPU Unit model, Ethernet Unit mode, node address, and network address)
	Controller Link Information on nodes participating in the Controller Link network (CPU Unit model, Controller Link Unit mode, node address, and network address) The following functions are also possible if the Controller Link Network Diagnostic Tool is started. Configuration node diagnosis (network participation status, current Controller Link Unit errors, current CPU Unit errors, and differences from node files), setting diagnosis (e.g., DM Area parameter setting consistency), line disconnection information diagnosis, transmission status diagnosis, node status (displaying current error status and error log), error log collection, and node file editing (node names, connection order, and Repeater Units)
	SYSMAC LINK Information on nodes participating in the SYSMAC LINK network (CPU Unit model, Controller Link Unit mode, node address, and network address)
	DeviceNet Information on nodes connected to DeviceNet for which EDS files are installed on the computer (DeviceNet Unit model, slave model, master/slave node addresses)
	CompoWay/F Information on nodes connected to a serial port in serial gateway mode or protocol macro mode for which CPS files are installed on the computer (CompoWay/F SLAVE model and CompoWay/F node address). Note: CS/CJ-series CPU Units with unit version 3.0 or later or Serial Communications Boards/Units with unit version 1.2 or later must be used.
	NT Link Information on nodes connected to 1:N NT Links (NS-series PT model and NT Link unit number) Note: Automatic detection of NS-series PTs connected serially to a CS/CJ-series PLC is also possible. (The NT Link Automatic Setting Function automatically changes the setting of the PLC's serial port to match those of the NS-series PT.)
	FINS networks, such as Ethernet, Controller Link, SYSMAC LINK, and DeviceNet Routing tables (FINS local routing tables and FINS network routing tables) Note: The FINS local routing table is transferred to the target PLC.
Setting functions	Ethernet Ethernet Unit settings (CPU Bus Unit System Settings)
	Controller Link User-set data link tables
	SYSMAC LINK Controller Link and SYSMAC LINK Unit settings (in allocated DM Area words), including automatically set data link parameters (transferred to the startup node set as the target PLC)
	DeviceNet DeviceNet Unit master parameters (remote I/O allocations, connection settings, device information check, communications cycle time, etc.) Slave parameters
	CompoWay/F CompoWay/F slave parameters (except for Temperature Controllers) Note: Parameters for CompoWay/F-compatible Temperature Controllers are set using the CX-Thermo, started as an application. PLC serial port communications settings (CPU Unit: part of PLC Setup, Serial Communications Boards/Units: allocated DM Area words)
	NT Link None
	FINS networks, such as Ethernet, Controller Link, SYSMAC LINK, and DeviceNet Routing tables (FINS local routing tables and FINS network routing tables) Note: The FINS local routing table is transferred to the target PLC.
Verification functions	Verifying communications/network configurations Verifying component parameters
Operations	The following operations are possible for the CPU Unit at the target PLC. Creating, editing, and transferring I/O tables Displaying current errors and error logs Changing the operating mode Transferring or verifying a manually set data link table Transferring or verifying a routing table (FINS local routing table)

Files Created by the CX-Integrator

Files	Contents	Details
Project files (.cin)	Connection information to relay PLC, all network configurations for target PLC, and parameters for DeviceNet masters, DeviceNet slaves, and CompoWay/F slaves	These files are used offline to check network configurations and parameters and for other purposes, such as printing. Each file consists of the following: Device type setting information of the relay PLC Communications Unit models connected to the target PLC (Ethernet Units, Controller Link Units, SYSMAC LINK Units, DeviceNet Units, and Serial Communications Boards/Units) Device models connected to the above CPU Units or Communications Units via communications (DeviceNet slaves, CompoWay/F slaves, NS-series PTs, etc.) Parameters for DeviceNet Master Unit and Device parameters and DeviceNet slaves (for all devices for which EDS files are installed on the computer including slaves from other manufacturers) Parameters for CompoWay/F slaves (for all components for which CPS files are installed on the computer (except for Temperature Controllers) Controller Link network parameters Controller Link and SYSMAC LINK Unit allocated DM Area words settings, including automatically set data link parameters Ethernet Unit CPU Bus Unit System Settings Serial Communications Board/Unit serial communications settings Note: Routing tables (local network tables and relay network tables) and user-set data link tables are not included in project files.
Network configuration files	DeviceNet network structure files (.npf)	Network configuration for one DeviceNet network connected directly to the target PLC (including master and slave parameters) Note: These are the same as the DeviceNet network structure files (.npf) created with DeviceNet Configurator version 2. Files created with DeviceNet Configurator version 2 can be imported/exported.
	Controller Link node files (.crg)	Network configuration for Controller Link networks connected directly to the target PLC
Component parameter files	DeviceNet device parameter files (.dvf)	Parameters for individual DeviceNet devices (master or slave) Note: These are the same as the DeviceNet device parameter files (.dvf) created with DeviceNet Configurator version 2. Files created with DeviceNet Configurator version 2 can be imported.
	CompoWay/F component parameter files (.xml)	Parameters for individual CompoWay/F slaves (except for Temperature Controllers) CPU Unit parameters (parts of PLC Setup: serial communications settings) Controller Link or SYSMAC LINK network parameters Controller Link and SYSMAC LINK Unit allocated DM Area words settings, including automatically set data link parameters Ethernet Unit CPU Bus Unit System Settings Serial Communications Board/Unit serial communications settings
Data link table files	Controller Link data link table files (.cl3)	Controller Link user-set data link tables Note: These are the same as the Controller Link data link table files (.cl3) created with the CX-Net. Files created with the CX-Net can be imported.
	SYSMAC LINK data link table files (.sl3)	SYSMAC LINK user-set data link tables Note: These are the same as the SYSMAC LINK data link table files (.sl3) created with the CX-Net. Files created with the CX-Net can be imported.
Routing table files	FINS local routing table files (.rtg)	Routing tables of the target PLC Note: These are the same as the FINS local routing table files (.rtg) created with the CX-Net. Files created with the CX-Net can be imported.
	FINS network routing table files (.rt3)	Routing tables for all PLCs on networks to which the target PLC belongs Note: These are the same as the FINS network routing table files (.rt3) created with the CX-Net. Files created with the CX-Net can be imported.

**Note:** With DeviceNet only, the following files can also be exported and saved.  
EDS files (.eds)  
The device list saved in CSV format (.csv)  
The I/O comments saved in CSV format (.csv)  
The device parameters of an OMRON DeviceNet Master Unit saved as an Open Network Controller DRM\_UNIT (virtual unit) file  
The device parameters of an OMRON DeviceNet Master Unit saved as a NetX Server (NetX Server for DeviceNet) file

**Note:** The CX-Integrator does not support files created in the DeviceNet Configurator Ver. 1.0 file format.



**CX-ONE**

**Personal computer Requirements**

Item	System Requirement*			
Operating System (OS) <sup>1</sup> Japanese or English version	Microsoft® Windows® 98SE	Microsoft® Windows® NT (Service Pack 6a)	Microsoft® Windows® 2000 (Service Pack 3 or higher)/ Windows® Me	Microsoft® Windows® XP
Main Unit	IBM AT compatible machine Pentium-class CPU 133MHz or higher. Pentium III 1GHz or higher is recommended.	IBM AT compatible machine Pentium-class CPU 133MHz or higher. Pentium III 1GHz or higher is recommended.	IBM AT compatible machine Pentium-class CPU 150MHz or higher. Pentium III 1GHz or higher is recommended.	IBM AT compatible machine Pentium-class CPU 300MHz or higher. Pentium III 1GHz or higher is recommended.
Memory	256MB or higher required <sup>2</sup>			
Hard drive	To install entire CX-One, about 1.6GB or more free space is required.			
Display	High quality display with SVGA (800 x 600) or higher and 256 colors or more.			
Optical drive	CD-ROM drive			
Communication port	At least 1 RS-232C port <sup>3</sup>			
Others	For online user registration via the Internet, you need appropriate hardware such as modem and access right for the Internet.			

- \*1 About operating System for CX-One:  
This product does not run on Microsoft Windows95 or other OS version than the specified System requirement. If you have such an operating System on a client computer, you must upgrade the operating System before installing this product. Note that required System and capacity of hard drive depend on your System environment.
- \*2 The required memory depends on the Support Software consisting CX-One. For details, see user's manuals.
- \*3 RS-232C port is required for connection with a PLC using CX-One Support Software. If you have only USB port on your Personal computer, use USB-RS-232C conversion cable (CS1W-CIF31).

**Software List to be Installed**

Shown below are CX-One Support Software installed with CX-One.

CX-One Support Software	Description	Required free space on hard drive	Remarks
CX-Programmer	Software to create and debug programs for SYSMAC CS/CJ series, C series, or CVM1/C series.	ca. 250MB	If necessary
CX-Integrator	Software to start up and configure FA networks such as Controller Link, DeviceNet, and CompoWay/F.	ca. 100MB	
CX-Position	Software to create and monitor various data for SYSMAC CS/CJ series NC Unit.	ca. 15MB	
CX-Motion	Software to create various data for MC Unit of SYSMAC CS/CJ series, alpha series, and CV series and to create and monitor MC programs.	ca. 40MB	
CX-Motion-NCF	Software to create and monitor various data for SYSMAC CS/CJ series NCF Unit.	ca. 100MB	
CX-Designer	Software to create screen data for programmable terminal NS series.	ca. 550MB	
CX-Process Tool	Software to create and debug instrument block programs for loop control Unit board, process, and loop CPU Unit of SYSMAC CS/CJ series.	ca. 65MB	
Face Plate Auto-Builder for NS	Software to automatically generate NS series project files for monitoring and tuning of a loop controller.	ca. 50MB	
CX-Protocol	Software to create data transmission procedure (protocol) with an external universal device that is connected to a serial communications board/Unit of SYSMAC CS/CJ series and SYSMAC alpha series.	ca. 20MB	
CX-Simulator	Software to debug programs for SYSMAC CS/CJ series without the CPU Unit by simulating the CPU operation on a Personal computer.	ca. 40MB	
CX-Thermo	Software to configure and adjust parameters for devices (Components such as temperature controller).	ca. 20MB	
Switch Box	Utility software to support PLC debugging. Input/output status and current values of address in a user-specified PLC can be monitored and modified easily.	ca. 5MB	
PLC Support Software	A group of Components that are commonly used by software that consists CX-One, such as CX-Programmer and CX-Integrator.	ca. 300MB	
CX-Server	Middleware required for communications between CX-One Support Software and OMRON's Components such as PLC, indicator, or temperature controller.		

**Note:** To install entire CX-One Support Software, about 1.6GB of free space is required for your Personal computer's hard drive. Make sure that sufficient free space is available.

# Ordering information

Part number	Description
CXONE-AL01C-E-UP	CX-One single user upgrade
CXONE-AL03C-E-UP	CX-One 3 user upgrade
CXONE-AL10C-E-UP	CX-One 10 user upgrade
CXONE-AL01C-E	CX-One single user
CXONE-AL03C-E	CX-One 3 user
CXONE-AL10C-E	CX-One 10 user
CXONE-AL30C-E	CX-One OEM site license

PC-based visualisation

# CX-OPC

**OPC- an open communications standard**

Reduce your data integration costs with the use of open software.

**Key features**

CX-OPC connects the OMRON PLC systems to the information world, - SCADA, MES or Microsoft environment using the open standard OPC client.

These products allow easy visualisation of machine information, through standard ready-to-use (graphical) components to create production and machine statistic reports or simple control applications.

No specialised knowledge of PLC systems or networks is needed to use these products. Any VBA or Visual Basic user can use OPC successfully.

The products represent a substantial time saving compared with conventional programming.



**General Data**

	Specification
<b>Supported PLC systems</b>	CS1, CJ1, C20, CXxK, CXxH, CXxp, SRM1, CPM, CQM1, CQM1H, C200H/-HS/-HX/-HG/-HE, C1000H, C2000H, CV/CVM1
<b>Communication</b>	<ul style="list-style-type: none"> <li>Peripheral port and Host Link port via COMx (RS-232C)</li> <li>Controller Link, SYSMAC NET, SYSMAC Link</li> <li>Ethernet</li> <li>Modem</li> </ul>
<b>Supported Software</b>	<ul style="list-style-type: none"> <li>MS Excel 97 and later</li> <li>MS Visual Basic 5 and later</li> <li>MS Visual C++ 6.0</li> <li>SCADA supporting OPC 2.04</li> <li>MES applications using OPC 2.04</li> </ul>

**Product Overview**

	Description	Model code
<b>Program</b>	OPC server to serial connection single application	CX-OPC-EVx.xx-S
	OPC server to serial connection 3 applications	CX-OPC-E03Vx.xx-S
	OPC server to serial connection 10 applications	CX-OPC-E10Vx.xx-S
	OPC server to serial+ network connection single application	CX-OPC-EVx.xx-N
	OPC server to serial + network connection 3 applications	CX-OPC-E03Vx.xx-N
	OPC server to serial + network connection 10 applications	CX-OPC-E10Vx.xx-N

**Functions**

<b>Program integration</b>	<ul style="list-style-type: none"> <li>Integration in VBA and Visual Basic via ActiveX® components</li> <li>The interoperability of CX-Server OPC has been tested with numerous commercially available OPC clients</li> </ul>
<b>Application</b>	Application-based display of PLC and OPC Server data with the features of MS Office products as well as VBA and Visual Basic
<b>OPC functions</b>	<ul style="list-style-type: none"> <li>Synchronous or Asynchronous communication</li> <li>Reading from cache or device</li> <li>Subscription update rates starting from 100 milliseconds</li> </ul>
<b>Standard controls</b>	<ul style="list-style-type: none"> <li>7 Segment- and Display control to display data in multiple formats</li> <li>Toggle button, Rotary Knob, Thumbwheel control and LED Indicator to write a value with a single click and to visualize the value at the same time</li> <li>Linear- and Rotational Gauge that can display data in a graphical way</li> <li>Data Logging, Timer and Linker controls to log data, trigger actions and connect third party ActiveX® controls</li> </ul>

Software

PC-based visualisation

# CX-Lite

**See your machine or production data easily in Microsoft excel.**

Display machine or process data in Microsoft Excel in minutes not hours.

**Key features**

CX-Server Lite connects the OMRON PLC systems to the world of Microsoft Office, Microsoft Programming languages.

By simply importing the CX-Server ActiveX® components into your application you can create a link to the PLC that lets you write production parameters and read production data, for example.

These products allow easy visualisation of machine information, through standard ready-to-use (graphical) components to create production and machine status reports or simple control applications.

No specialised knowledge of PLC systems or networks is needed to use these products. Any VBA or Visual Basic user can use CX-Server Lite easily and successfully.

The products represent a substantial time saving compared with conventional programming.

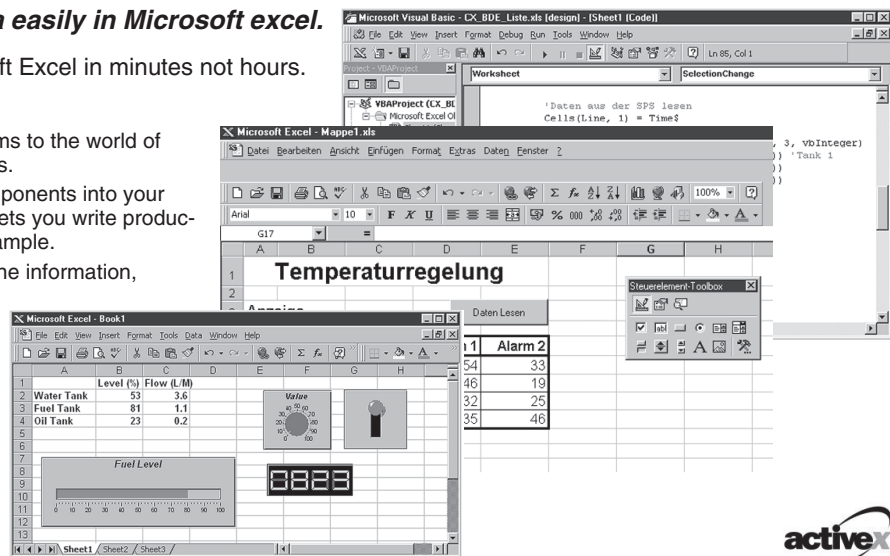

**General Data**

	Specification
<b>Supported PLC systems</b>	CS1, CJ1, C20, CXxK, CXxH, CXxp, SRM1, CPM, CQM1, CQM1H, C200H/-HS/-HX/-HG/-HE, C1000H, C2000H, CV/CVM1
<b>Communication</b>	<ul style="list-style-type: none"> <li>• Peripheral port and Host Link port via COMx (RS-232C)</li> <li>• Controller Link, SYSMAC NET, SYSMAC Link</li> <li>• Ethernet</li> <li>• Modem</li> </ul>
<b>Supported Software</b>	<ul style="list-style-type: none"> <li>• MS Excel 97 and later</li> <li>• MS Visual Basic 5 and later</li> <li>• MS Visual C++ 6.0</li> </ul>

**Product Overview**

	Description	Model code
<b>Program</b>	Microsoft Excel interface to serial connection only single application	CX-LITE-EVx.xx-S
	Microsoft Excel interface to serial connection 3 applications	CX-LITE-E03Vx.xx-S
	Microsoft Excel interface to serial connection 10 application	CX-LITE-E10Vx.xx-S
	Microsoft Excel interface to serial+ network connection single application	CX-LITE-EVx.xx-N
	Microsoft Excel interface to serial + network connection 3 applications	CX-LITE-E03Vx.xx-N
	Microsoft Excel interface to serial + network connection 10 application	CX-LITE-E10Vx.xx-N

**Functions**

<b>Program integration</b>	<ul style="list-style-type: none"> <li>• Integration in VBA and Visual Basic via ActiveX® components</li> <li>• Supports the use of ActiveX® components of other suppliers</li> </ul>
<b>Application</b>	Application-based display of PLC and OPC Server data with the features of MS Office products as well as VBA and Visual Basic
<b>OPC functions</b>	<ul style="list-style-type: none"> <li>• Synchronous or Asynchronous communication</li> <li>• Reading from cache or device</li> <li>• Subscription update rates starting from 100 milliseconds</li> </ul>
<b>Standard controls</b>	<ul style="list-style-type: none"> <li>• 7 Segment- and Display control to display data in multiple formats</li> <li>• Toggle button, Rotary Knob, Thumbwheel control and LED Indicator to write a value with a single click and to visualize the value at the same time</li> <li>• Linear- and Rotational Gauge that can display data in a graphical way</li> <li>• Data Logging, Timer and Linker controls to log data, trigger actions and connect third party ActiveX® controls</li> </ul>

PC-based visualisation

# CX-Supervisor

## SCADA for your machine

PC based HMI for demanding machine applications

### Key features

Process visualising with outstanding price/performance ratio

- Powerful functions can be used to create animated process images.
- Simple applications can be created rapidly with the aid of a large number of predefined functions and libraries, and even very complex applications can be generated with the powerful programming language (Scripts).
- A clear, straightforward structure minimises familiarisation times. Simple, intuitive handling and high user friendliness
- Versatile test and documentation facilities.
- OPC allows connections to Version 2 OPC Servers.
- Database support for SQL, ODBC, MS Access, MS Excel, dBase, CSV and more.
- Importing ActiveX® components makes it possible to create flexible applications and extend functionality.

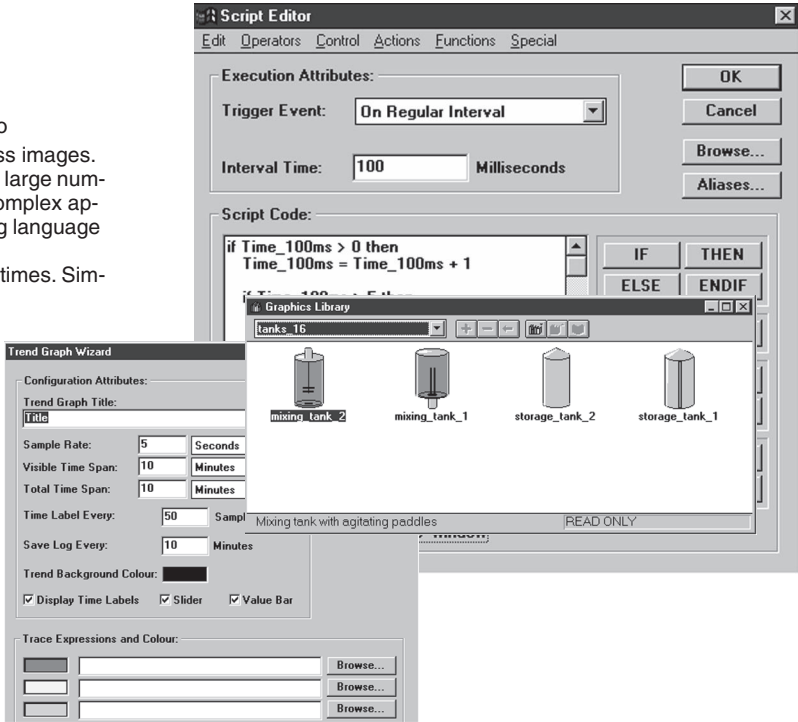

## General Data

	Specification
Number of process points	8,000
Number of process images	No limit
Supported PLC systems	CS1, CJ1, SRM1, CPM, C20, CXxK, CXxH, C20P, CQM1, CQM1H, C200H/-HS/-HX/-HG/-HEC500, C1000H, C2000H, CV/CVM1
Supported OMRON controllers	E5AF-A/-H, E5EF-A/-H/-BA/-BAH, E5AJ-A, E5AK-A/-PRR, E5EK-A/-PRR, E5AX-LA/-MA/-PRR
Communication	<ul style="list-style-type: none"> <li>• Peripheral port and SYSMAC NET Host Link interface via COMx</li> <li>• SYSMAC Link</li> <li>• Controller Link</li> <li>• Ethernet</li> <li>• Modem</li> <li>• DDE</li> <li>• OPC (Client)</li> <li>• ActiveX®</li> </ul>

## Product Overview

Program	Description	Model code
	Developmet package	CX-SUPERVISOR-VX.XX
	Runtime CD + runtime token (3.5' floppy disc)	CX-SUPERVISOR-RUN-TOK-Vx.xx
	Runtime CD + runtime dongle (parallel port)	CX-SUPERVISOR- RUN-HL-Vx.xx
	Runtime CD + USB key	CX-SUPERVISOR-RUN-USB-Vx.xx
	Runtime token only (3.5' floppy disc)	CX-SUPERVISOR-TOK-Vx.xx
	Runtime dongle only (parallel port)	CX-SUPERVISOR-HL-Vx.xx
	Runtime USB key only	CX-SUPERVISOR-USB-Vx.xx
	Demo version limited to 2 hours runtime.	CX-SUPERVISOR-DEMO2-Vx.xx

**Functions**

Programming types	<ul style="list-style-type: none"> <li>• Predefined functions and graphic elements (libraries, animation editor)</li> <li>• Script language for solving complex control and data processing tasks</li> <li>• VBA and JAVA scripts can be imported</li> <li>• Active components can be incorporated with the ActiveX® property browser</li> <li>• HTML texts can be imported/displayed with Internet Explorer functionality (V.5.0 or higher)</li> </ul>
Edit options	<p>Toolbars for creating and aligning graphic elements; libraries with a wide choice of predefined modules (Wizard function)</p> <p>Project Editor: Manages the process images you have created</p> <p>Points Editor: Creates and manages process points and internal variables</p> <p>Animation Editor: Assigns display variables, colour changes, movement etc. to graphic objects</p> <p>Alarm Editor: Assigns alarm limits/ranges to process points and internal variables</p> <p>Data block Editor: Creates and manages Data block files, online downloading to the PLC</p> <p>Script Editor: A powerful programming language with graphic and mathematical functions and commands for program control, file management etc.</p>
Mathematical functions	trigonometric, logarithmic and arithmetic functions
Math operators	+, -, *, /, %, =, <, >, <=, >=, !=, ==
Logical operations	AND, OR, NOT, TRUE, FALSE
Conditional program execution	IF-THEN-ELSE/ELSEIF, SELECT CASE
Display functions	Variables, text, date, time, comprehensive object animation options
Graphic functions	Straight line, rectangle, polygon, circle (outline or filled-in); bar chart, trend chart, scatter graph, display instruments, bitmap, OLE
Special functions	Keyboard input, write/read CSV file, program launch, Data block manager, alarms, password entry/verification with different authorisation levels, DDE/NetDDE/COM/DCOM/OPC-link to other WINDOWS applications, data logging, parameter transfer with ActiveX® events.
Documentation	<ul style="list-style-type: none"> <li>• User-definable comments on all process points and internal variables</li> <li>• Printout of process images, variables lists, scripts etc.</li> </ul>
Test options	Error Logger, Debugger

# PC-Based visualization

## Computer hardware and software requirements

Supported operating systems	Windows 2000, XP and NT4.0 (Service Pack 5 and later)	
Processor	Min. Pentium with 200 MHz or higher, Recommended 800 MHz or higher with Multithreading.	
Memory requirements	Hard disk	40 MB of free memory space
	RAM	Min. 64 MB, 256 MB recommended
Screen	VGA graphic, SVGA graphic with 1024x768 or higher recommended	
Peripheral connections <sup>1</sup>	1.44 MB disk drive COMx serial port Mouse Parallel printer port (any WINDOWS supported printer)	

<sup>1</sup> Peripheral connection only needed for CX-Supervisor

## Ordering Information

Part number	Description
CX-SUPERVISOR-VX.XX	Developmet package
CX-SUPERVISOR-RUN-TOK-Vx.xx	Runtime CD + runtime token (3.5" floppy disc)
CX-SUPERVISOR-RUN-HL-Vx.xx	Runtime CD + runtime dongle (parallel port)
CX-SUPERVISOR-RUN-USB-Vx.xx	Runtime CD + USB key
CX-SUPERVISOR-TOK-Vx.xx	Runtime token only (3.5" floppy disc)
CX-SUPERVISOR-HL-Vx.xx	Runtime dongle only (parallel port)
CX-SUPERVISOR-USB-Vx.xx	Runtime USB key only
CX-SUPERVISOR-DEMO2-Vx.xx	Demo version limited to 2 hours runtime.
CX-LITE-EVx.xx-S	Microsoft Excel interface to serial connection only single application
CX-LITE-E03Vx.xx-S	Microsoft Excel interface to serial connection 3 applications
CX-LITE-E10Vx.xx-S	Microsoft Excel interface to serial connection 10 application
CX-LITE-EVx.xx-N	Microsoft Excel interface to serial+ network connection single application
CX-LITE-E03Vx.xx-N	Microsoft Excel interface to serial + network connection 3 applications
CX-LITE-E10Vx.xx-N	Microsoft Excel interface to serial + network connection 10 application
CX-OPC-EVx.xx-S	OPC server to serial connection single application
CX-OPC-E03Vx.xx-S	OPC server to serial connection 3 applications
CX-OPC-E10Vx.xx-S	OPC server to serial connection 10 application
CX-OPC-EVx.xx-N	OPC server to serial+ network connection single application
CX-OPC-E03Vx.xx-N	OPC server to serial + network connection 3 applications
CX-OPC-E10Vx.xx-N	OPC server to serial + network connection 10 application

ALL DIMENSIONS SHOWN ARE IN MILLIMETERS.  
To convert millimeters into inches, multiply by 0.03937. To convert grams into ounces, multiply by 0.03527.